



# YOUR LED DISPLAY PARTNER

—  
[www.eagerled.com](http://www.eagerled.com)

# 40+

EagerLED Supply More Than  
40 Kinds of LED Displays

Shenzhen Eager LED Co., Ltd.

# ABOUT US

## EagerLED, Your LED Display Partner

Since its establishment in 2009, EagerLED has been engaged in indoor and outdoor full-color LED displays, and has become one of the leaders in LED display industry.

EagerLED attaches great importance to the research and development of LED display products. EagerLED customers can receive information about new products and new technologies from time to time.

After more than 10 years of development, EagerLED products sell well in more than 90 countries and regions around the world, especially in Europe, North America, South America, the Middle East and Africa.

EagerLED would like to establish long-term and mutually beneficial relations with customers and believe that customers are the most important resources of any enterprise.

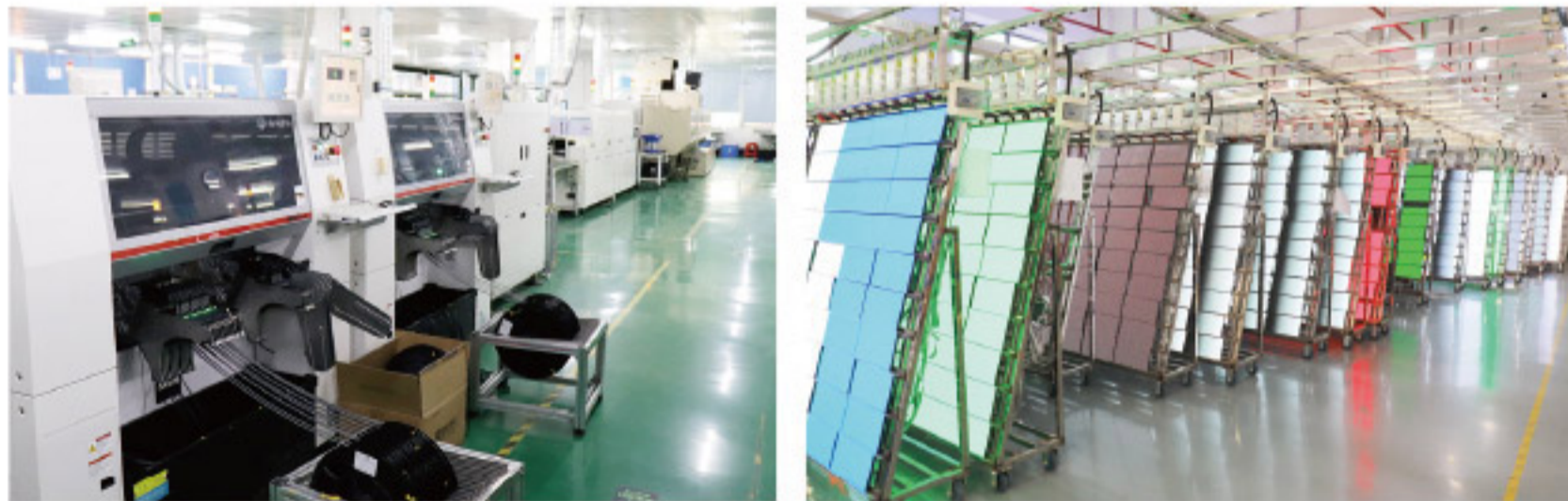

Sales Dept.



Marketing Dept.



Finance Dept.



Logistics and Purchasing Dept.



Product Engineering Dept.



Production Dept.



Technical and QC Dept.

# CUSTOMER VISITING

# LED DISPLAY CONTENT



- 01 Indoor HD LED Display
- 02 Rental LED Display
- 03 Commercial LED Display
- 04 Flexible LED Display
- 05 Transparent LED Display
- 06 Poster LED Display
- 07 Stadium Perimeter LED Display



# EA640F2

Indoor Front Service LED Display



EA640F2 LED display is a visually stunning produce, featuring a front service design for its LED modules, power supply and receiving card. It is an ideal solution for indoor fixed installation front service screen.

01

### 4:3 Ratio Cabinet Design

Cabinet size 640x480mm is 4:3 aspect ratio, easy to make 16:9 screen.

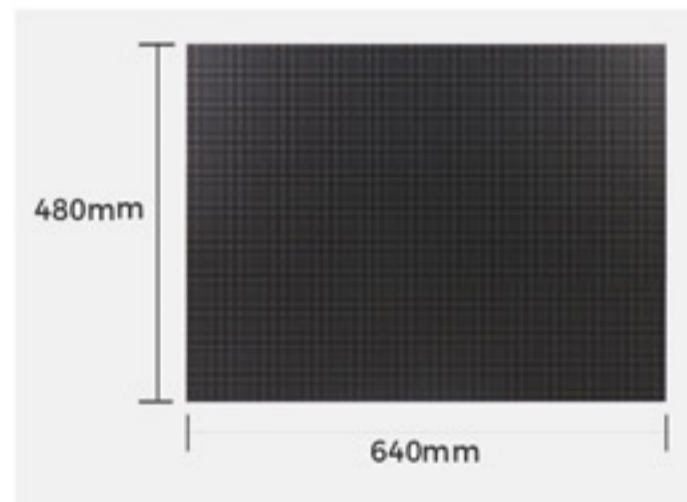

02

### Full Front Service

The full front maintenance design of this LED display allows for easy maintenance of the LED module, power supply, and receiving card from the front.



03

### Unique Appearance

The cabinet has a beautiful and generous appearance design with rich layering, which can attract users' attention.



04

### Perfect Structure Design

The fast locks can be operated with one hand, no tools required. More support column designs to ensure the flatness of the module.

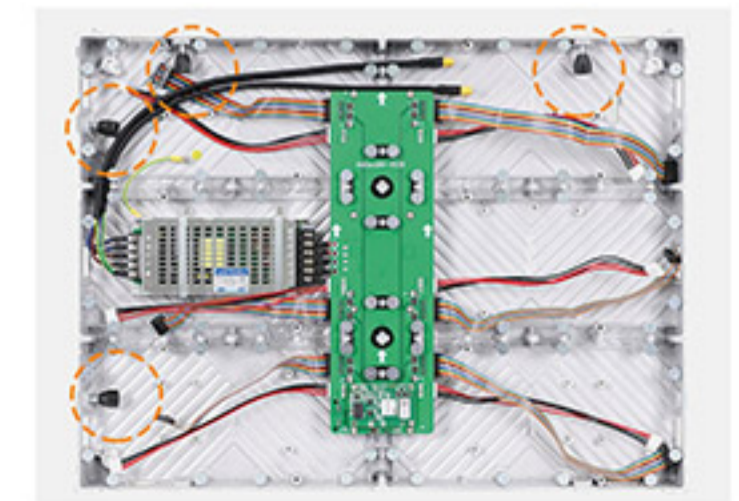

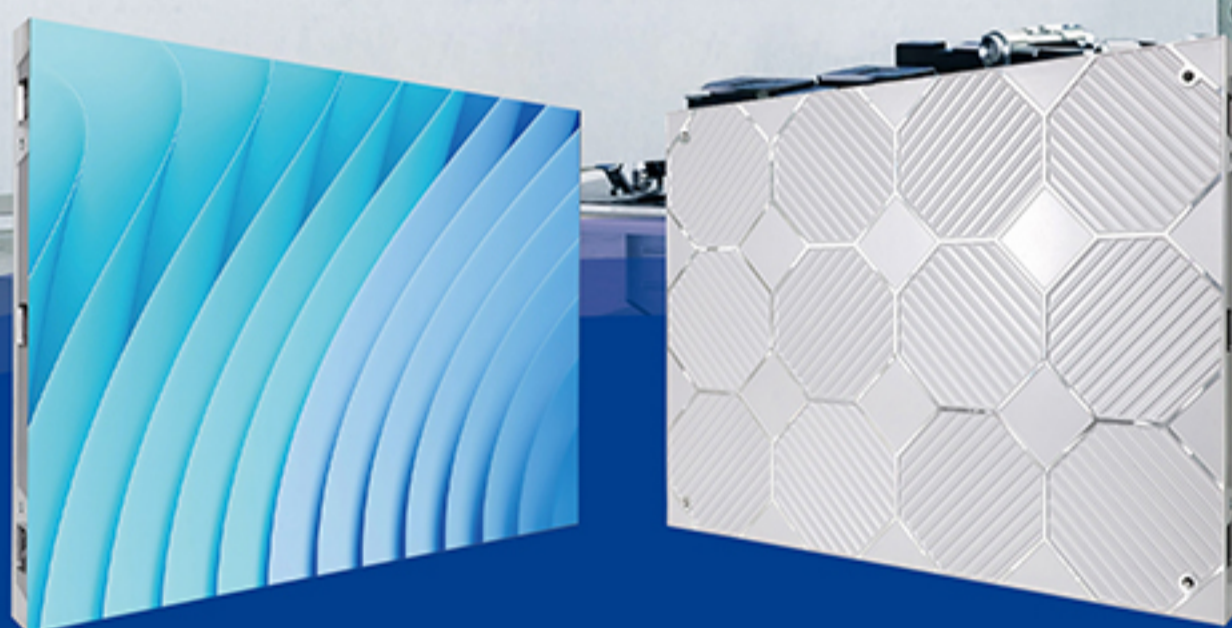

# EA640H1

## Indoor Front Service LED Display

EA640H1 series LED display adopts a hub connection design. It is an ultra-thin small-pitch LED display with a front-service design. The LED module is thin and light, and the box structure is simple. It deserves your choice.

### 01

#### 640x480mm Size 4:3 Ratio Design

EA640H1 LED Display is designed with 4:3 golden ratio, specially designed for a variety of 16:9 LED large screens.



### 02

#### Front Service Design

EA640H1 LED screen front service design, combined with electric vacuum clamp, makes maintenance easy.



### 03

#### HUB Connection

No additional DC power cords and cables are required, and the module is easy to install, saving time and effort.



### 04

#### Unique Appearance

The cabinet has a beautiful and generous appearance design with rich layering, which can attract users' attention.

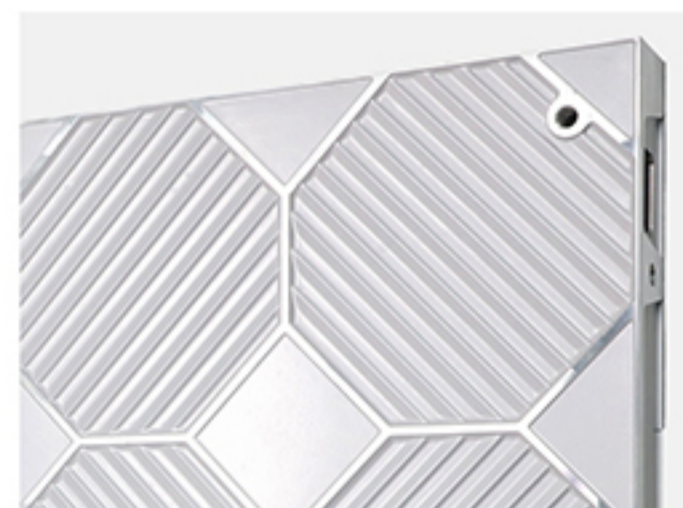



# EA250W2

## Indoor Wallpaper Front Service LED Display

EA250W2 indoor LED screen can be directly installed on the wall, with simple structure and support for front maintenance. EA250W2 indoor LED wall is suitable for various indoor commercial displays.



500x250mm 750x250mm 1000x250mm 500x500mm 1000x500mm

Five sizes of LED display for customers to choose

### 01

#### Front Service Design

EA250W2 LED screen supports front service, which is simple and efficient with the vacuum suction cup tool.



### 02

#### Cabinet Structure Design

EA250W2 series LED cabinet has beautiful design and reasonable internal layout.

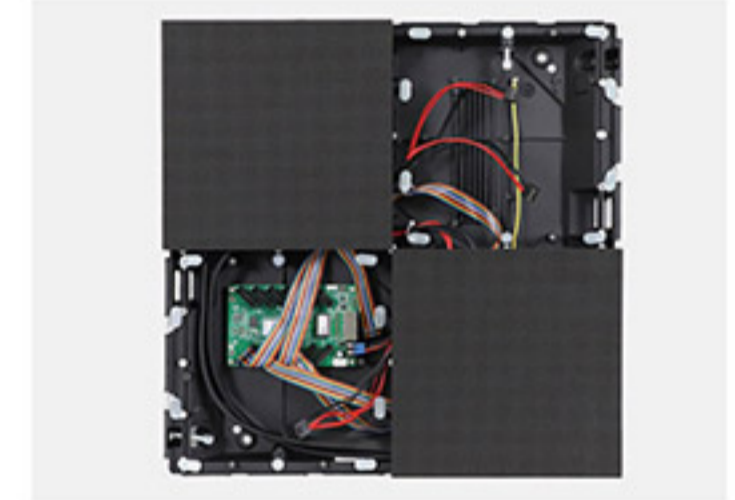

### 03

#### Beveled Cabinet

Supports customized 45-degree angled cabinet, and the screen can be spliced at 90 degrees. (optional)

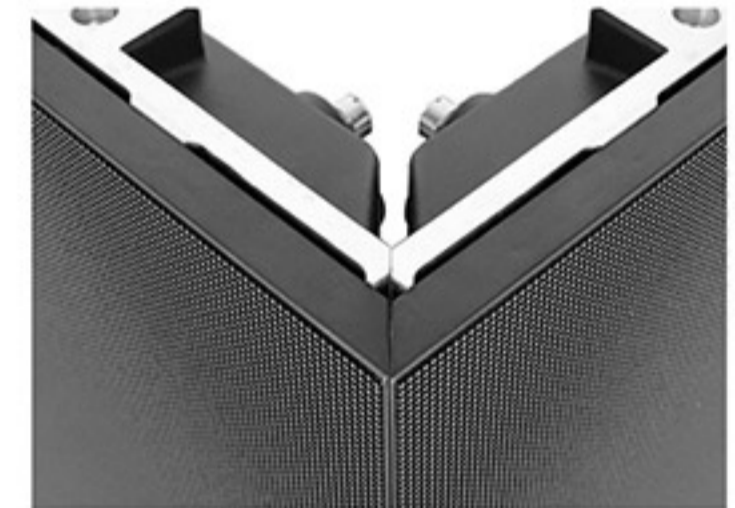

### 04

#### Wall Mounted Installation

EA250W2 wallpaper LED display can be directly installed on the wall, and the screen fits the wall perfectly.

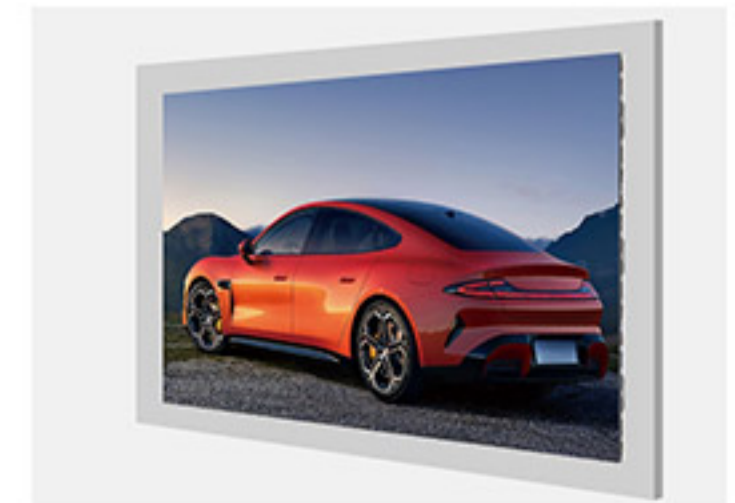



# EA250WH1

## Indoor Wallpaper Front Service LED Display

EA250WH1 indoor wallpaper LED display adopts ultra-thin design, easy to install. Full front service, wireless connection, ideal for indoor environments.

1000x250mm

750x250mm

500x250mm

Various sizes of LED display for customers to choose

### 01

#### Front Service Design

EA250WH1 LED display adopts a front service design, and the LED modules can be easily serviced with a vacuum suction cup.



### 02

#### Custom Beveled Cabinets

Support custom left and right beveled cabinets, adapt to 90-degree corners, and have a wide range of applications. (optional)



### 03

#### Thin and light Cabinet

At approximately 31mm thick, this cabinet has a lightweight design and excellent flatness.



### 04

#### Easy to Install

EA250WH1 LED display is free of structural installation and can be directly installed on the wall.



## 01 Indoor HD LED Display



# EA250WH2

## Indoor Wallpaper Front Service LED Display

EA250WH2 indoor wallpaper LED display adopts ultra-thin design, easy to install. Full front service, wireless connection, ideal for indoor environments.

1000x500mm 1000x250mm 750x250mm 500x250mm

Various sizes of LED display for customers to choose

### 01

#### Front Service Design

EA250WH2 LED display adopts a front service design, and the LED modules can be easily serviced with a vacuum suction cup.



### 02

#### Custom Beveled Cabinets

Support custom left and right beveled cabinets, adapt to 90-degree corners, and have a wide range of applications. (optional)



### 03

#### Thin and light Cabinet

At approximately 33mm thick, this cabinet has a lightweight design and excellent flatness.



### 04

#### Easy to Install

EA250WH2 LED screen can be mounted on the wall and also supports hanging installation.





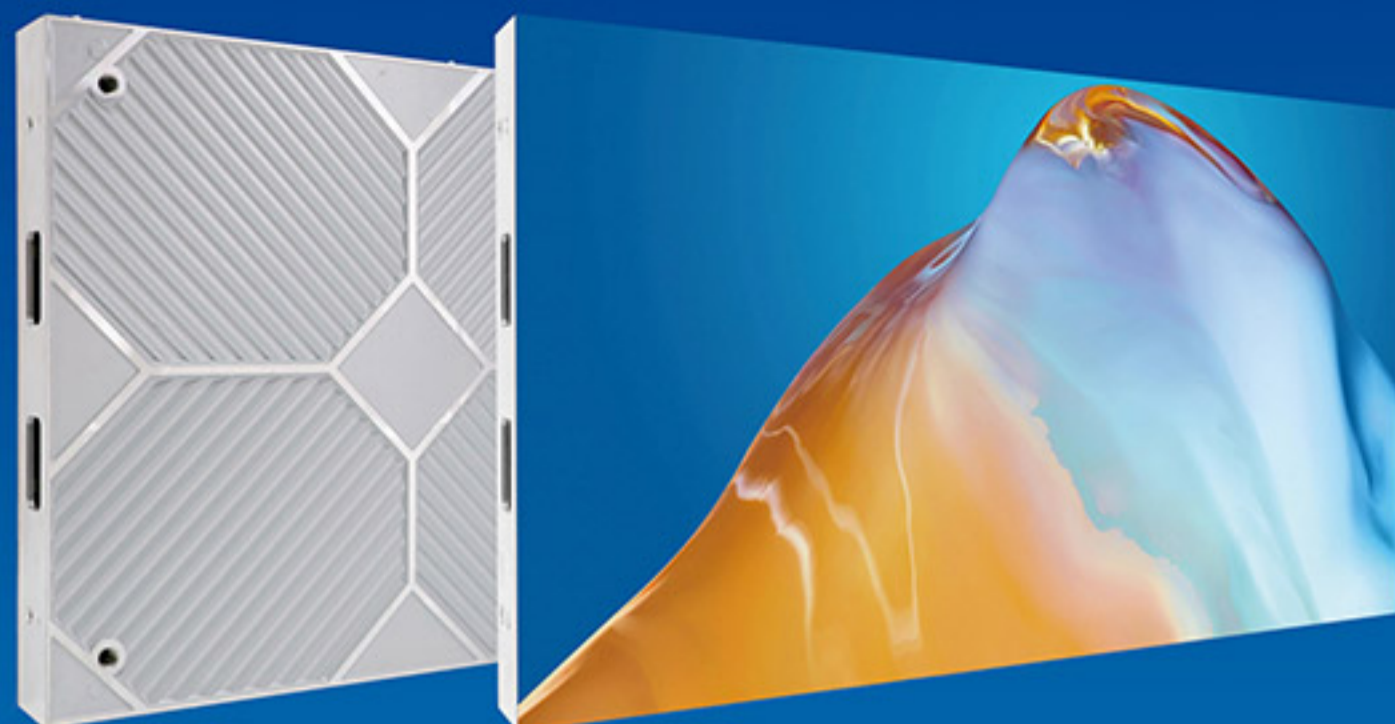

## EA169F3

### Indoor Front Service LED Display

EA169F3 LED Display features a front-access design and a 16:9 aspect ratio, with a high-definition display measuring 600 x 337.5 mm. Utilizing advanced image processing technology, this series delivers stunning image quality, making it an ideal solution for indoor displays.



#### 01

##### 600x337.5mm Size 16:9 Ratio Design

The 16:9 ratio LED display, easy to create full HD, 2K, 4K, 8K video walls.

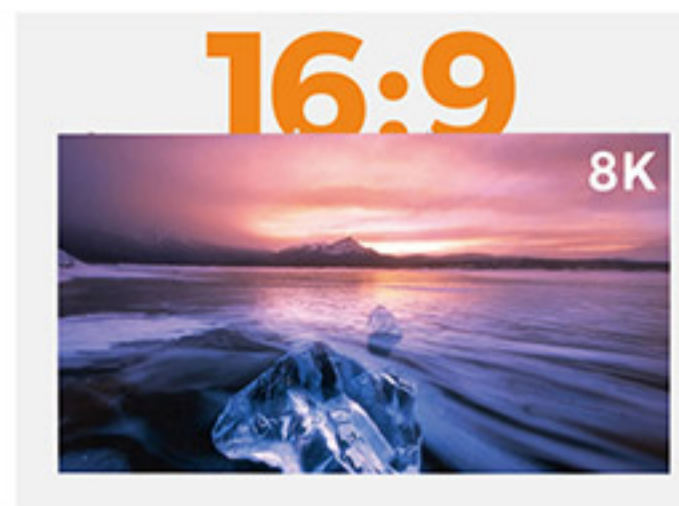

#### 02

##### Front Service Design

EA169F3 LED display has a front-service design, making it easy to maintain magnetic LED modules using vacuum suction cups.

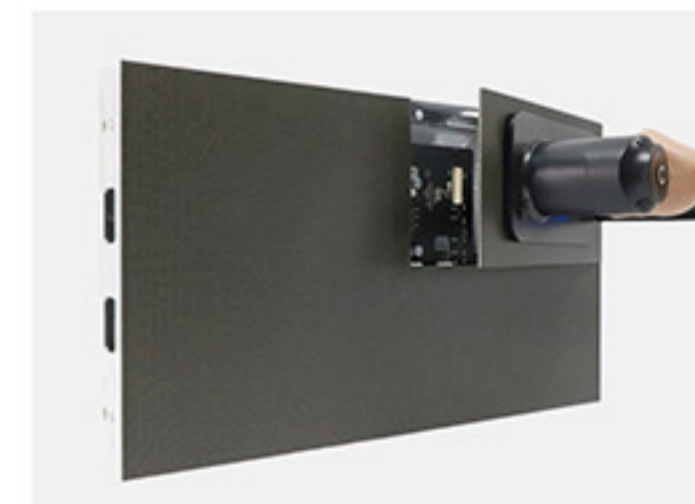

#### 03

##### Unique Appearance

The cabinet has a beautiful and generous appearance design with rich layering, which can attract users' attention.



#### 04

##### HUB Connection

EA169F3 LED display adopts Hub connection, which is more convenient and faster without the need for wiring harness connection.

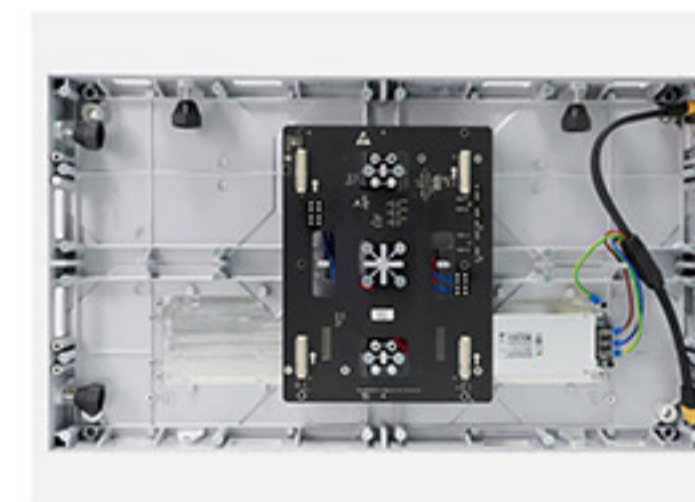

# EA169F2

## Indoor Front Service LED Display

EA169F2 indoor LED display adopts front maintenance design, 16:9 cabinet size, providing high-definition visual experience.



### 01

#### 640x360mm Size 16:9 Ratio Design

The 16:9 ratio LED display, easy to create full HD, 2K, 4K, 8K video walls.

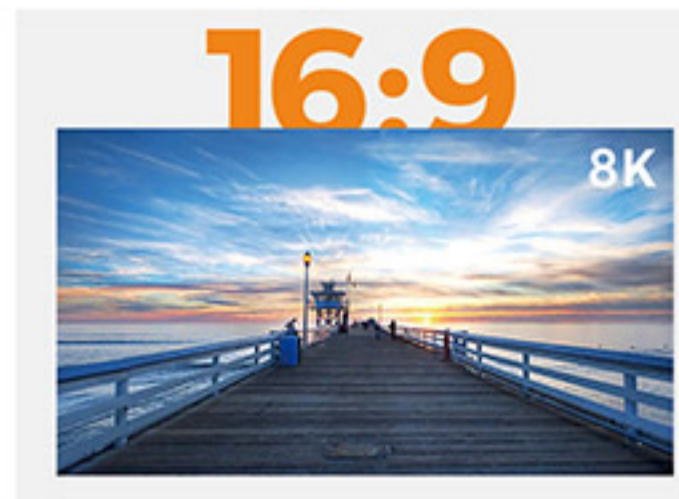

### 02

#### Front Service Design

EA169F2 LED display has a front-service design, making it easy to maintain magnetic LED modules using vacuum suction cups.

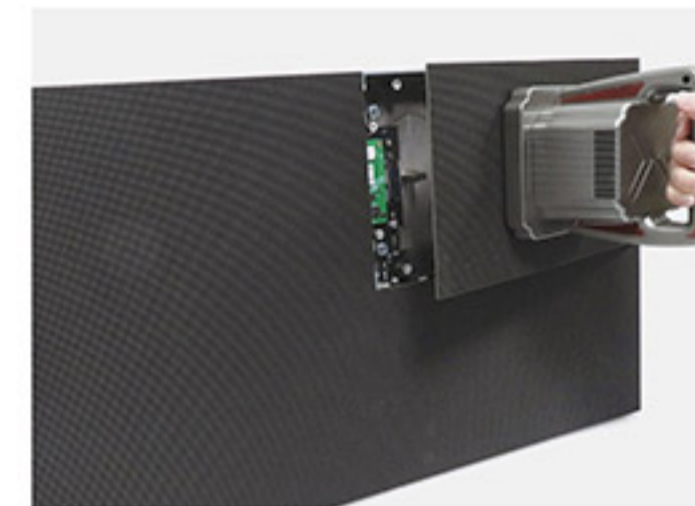

### 03

#### Perfect Structure Design

The cabinet with a bottom case provides improved heat dissipation, while its fast lock design on all sides allows for easy assembly.



### 04

#### HUB Connection

EA169F2 LED display adopts Hub connection, which is more convenient and faster without the need for wiring harness connection.

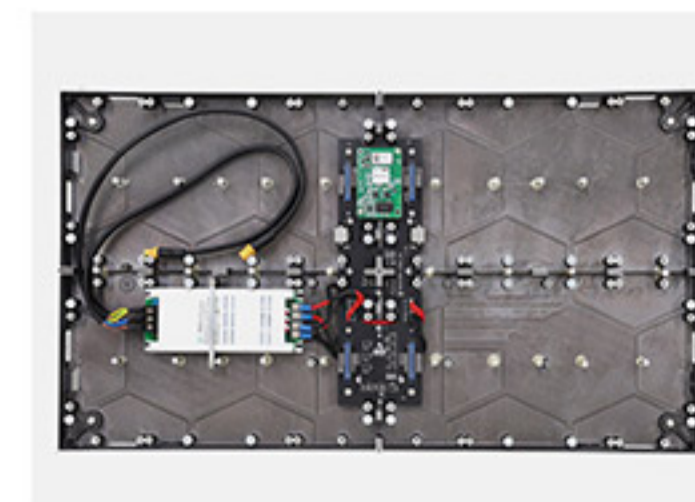



# EA600COB1

## Indoor COB Front Service LED Display

EA600COB1 LED display adopts the latest COB LED display technology, providing a stronger and more reliable connection, ultra-light and ultra-thin body design, front maintenance, and easy installation and maintenance.

Small Pitch P0.78/P0.93/P1.25/P1.56/P1.87

### 01

#### 600x337.5mm Size 16:9 Ratio Design

The 16:9 ratio LED display, easy to create full HD, 2K, 4K, 8K video walls.

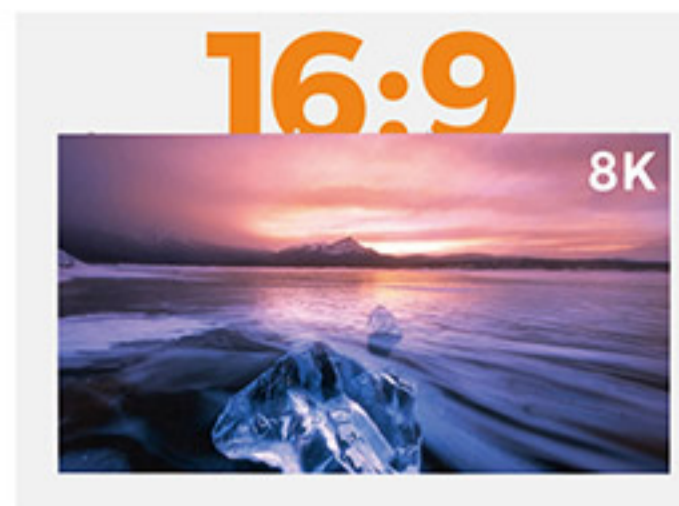

### 02

#### Front Service Design

EA600COB1 LED screen front maintenance design, combined with electric vacuum clamp, makes maintenance easy.



### 03

#### COB LED Module

COB LED technology offers superior pixel pitch, energy efficiency, higher contrast, smoother surfaces and better reliability.

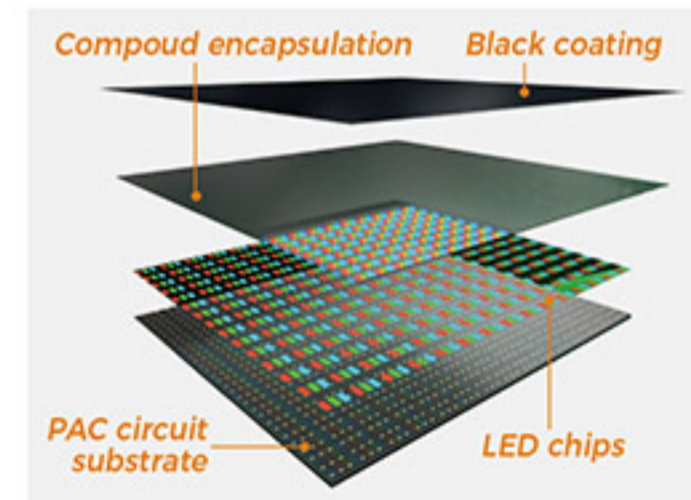

### 04

#### HUB Connection

LED module data and power input plug-and-play design, no need for additional DC power lines and cables, easy to install, save trouble and effort.





# EA600COB2

Indoor COB Front Service LED Display



EA600COB2 LED screen uses advanced COB display technology and has a stronger and more stable connection performance. Its ultra-light and thin design not only improves convenience, but also realizes the front maintenance function, greatly simplifying the maintenance process.

## 01

### 600x337.5mm Size 16:9 Ratio Design

The 16:9 ratio LED display, easy to create full HD, 2K, 4K, 8K video walls.



## 02

### Full Front Service

EA600COB2 adopts front service design, which makes maintenance simple and quick.



## 03

### COB LED Module

COB LED technology offers superior pixel pitch, energy efficiency, higher contrast, smoother surfaces and better reliability.

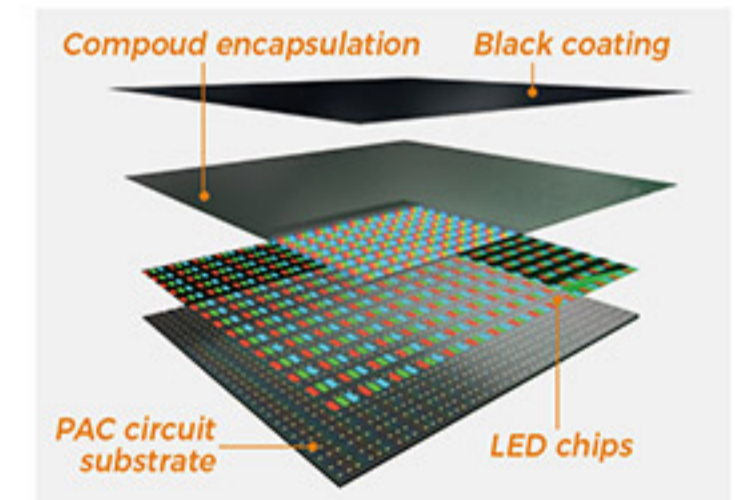

## 04

### HUB Connection

LED module data and power input plug-and-play design, no need for additional DC power lines and cables, easy to install, save trouble and effort.

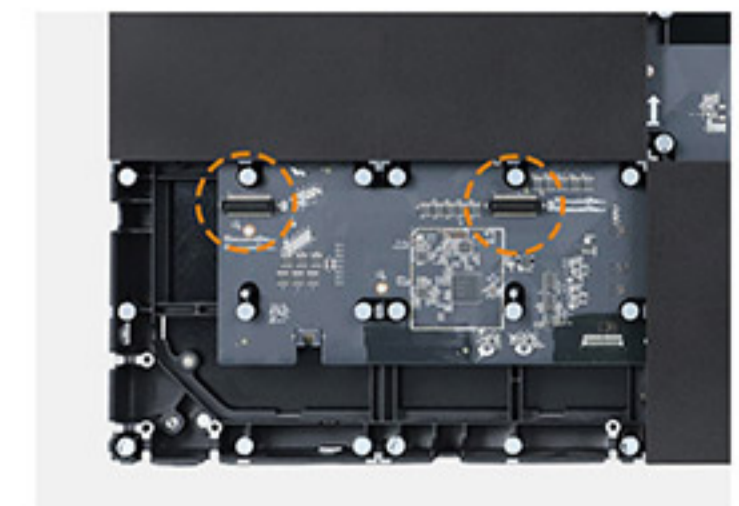



## EA640DF

### Indoor Double Face LED Display

EA640DF is an indoor double-sided LED screen specially designed for hanging purposes. Whether you're viewing the screen from the front or the back, you can clearly see what's displayed. Both sides support front service, saving maintenance time and costs, etc.

#### 01

##### Double Face LED Display

Double-sided display, the screen can be displayed from both front and rear directions.



#### 02

##### Double Face Front Service Design

With the front maintenance design, the suction cup easily maintains the LED modules on both sides of the magnetic field.



#### 03

##### Hanging Installation

The hanging design of the double face display makes it ideal for indoor venues, especially for advertising, signage, displays, etc.



#### 04

##### Perfect Structure Design

The cabinet is beautiful and elegant, and the structure is exquisite, ensuring the flatness of the modules on both sides.





## EA500C6

### 500×500mm Rental LED Display

EA500C6 LED display adopts quick-lock design and supports bending installation, making it easy and fast to install. The cabinet is made of die-cast aluminum, and all screws and quick locks are made of stainless steel, making it stronger and more durable. It is an ideal rental cabinet.

#### 01

##### Corner Protector for LED

EA500C6 rental LED display is designed with four corner guards to protect the LED screen.



#### 02

##### Quick Install

EA500C6 Series LED screen two fast Locks on left and top side, ensure faster assembly and better screen flatness.

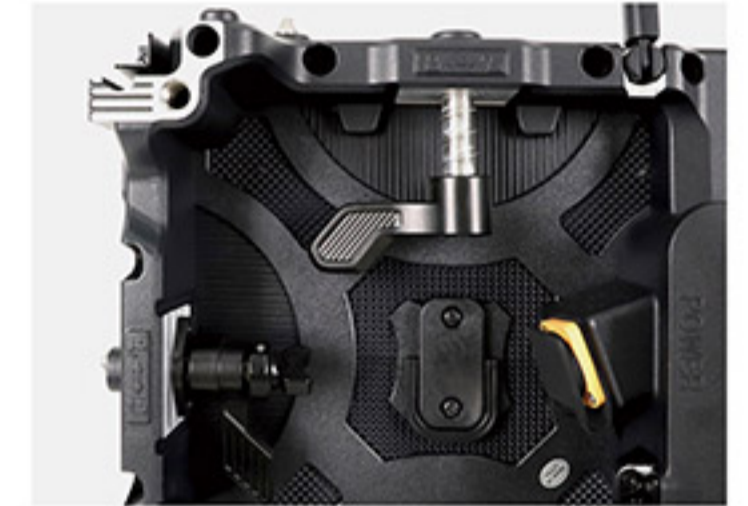

#### 03

##### Curved Installation

EA500C6 rental LED display wall supports curved installation, and can be installed in inner arc or outer arc.



#### 04

##### Mixed Splicing

EA500C6 and EA1000C6 cabinets can be easily spliced up and down, greatly meeting the different needs of stage design.





# EA1000C6

## 500×1000mm Rental LED Display

EA1000C6 LED screen adopts a convenient quick-lock design and supports curved installation. The cabinet is made of durable die-cast aluminum, and all screws and quick locks are made of stainless steel, which increases the overall sturdiness and durability.

### 01

#### Corner Protector for LED

EA1000C6 rental LED display is designed with four corner guards to ensure the integrity of the LED display.



### 02

#### Quick Install

There are two quick locks on the left and top sides of EA1000C6 series LED screen to ensure faster assembly and better screen flatness.

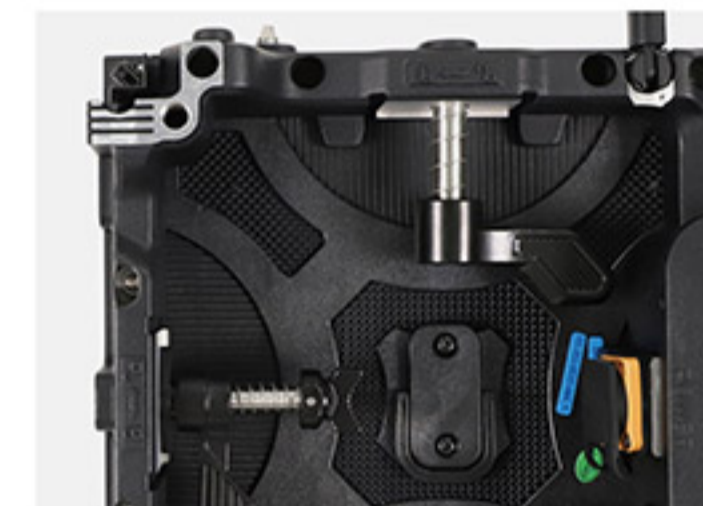

### 03

#### Curved Installation

EA1000C6 rental LED display wall has the flexibility of arc installation.

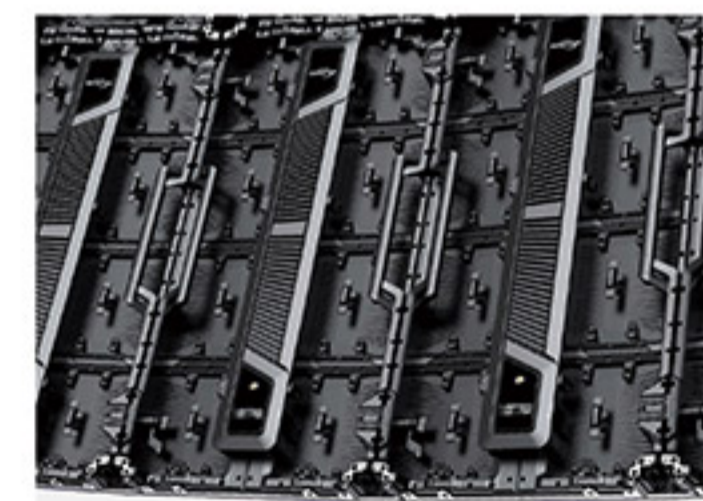

### 04

#### Mixed Splicing

EA1000C6 and EA500C6 cabinets can be easily spliced up and down, greatly meeting the different needs of stage design.



## 02 Rental LED Display



# EA500C5S

## 500x500mm Rental LED Display

EA500C5S rental LED screen adopts a 45-degree bevel cabinet design, supports right-angle splicing, and can form a cube display effect, which is suitable for the diverse needs of the rental market.

### 01

#### 45° Beveled LED Cabinet

EA500C5S series is designed for the rental market. The 45-degree bevel cabinet is specially designed.



### 02

#### 90 Degree Splicing

The two cabinets of EA500C5S LED display can be spliced at right angles to achieve flexible display effects.



### 03

#### Splicing Cube LED Display

EA500C5S rental LED display supports cube splicing and is designed for creative display.

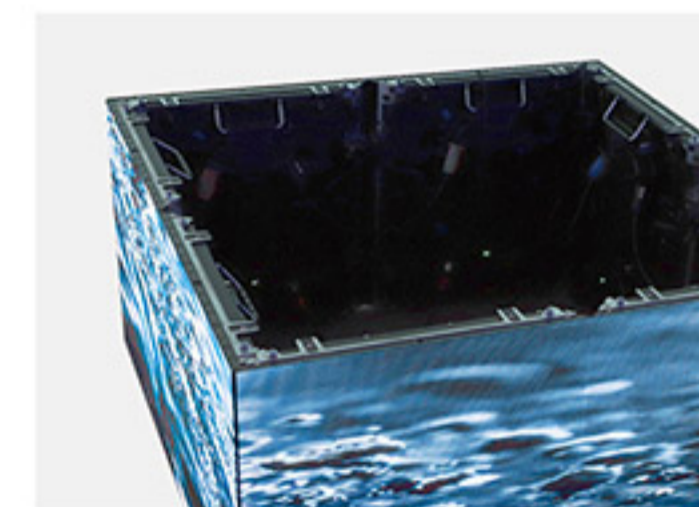

### 04

#### Curve Lock (Optional)

EA500C5S LED display can be equipped with curved locks to achieve curved installation.







# EA640C2

## 640x640mm Rental LED Display

EA640C2 rental LED display is suitable for the popular 320x160mm LED modules in the market. The cabinet is equipped with a quick lock and a positioning ball, making installation and removal more convenient.

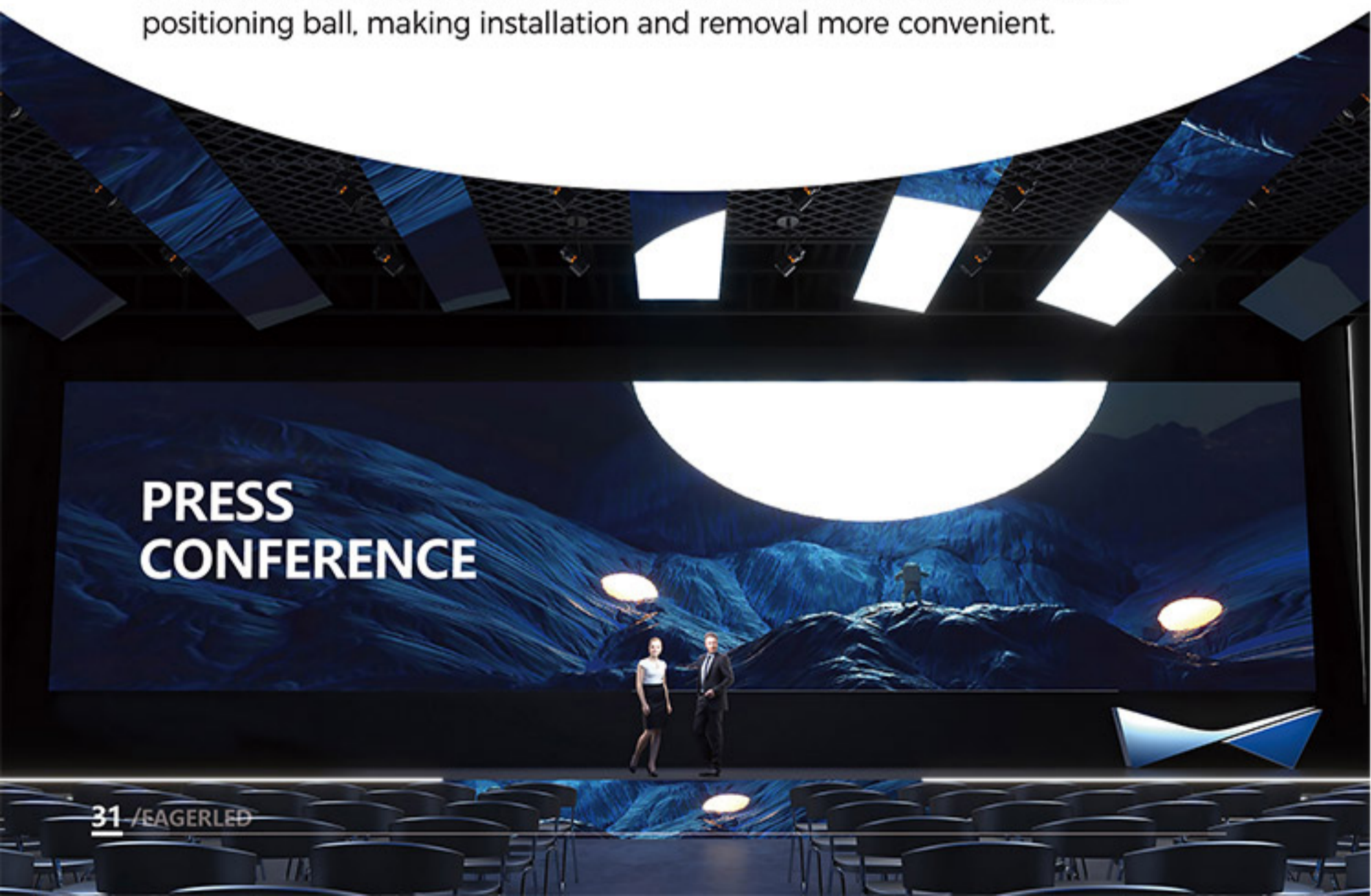

### 01

#### Openable Back Cover

The rear cover of EA640C2 rental LED display can be quickly opened for maintenance, and the fanless design ensures silent operation.



### 02

#### Fast Locks

EA640C2 rental LED display has a quick lock to make assembly faster.

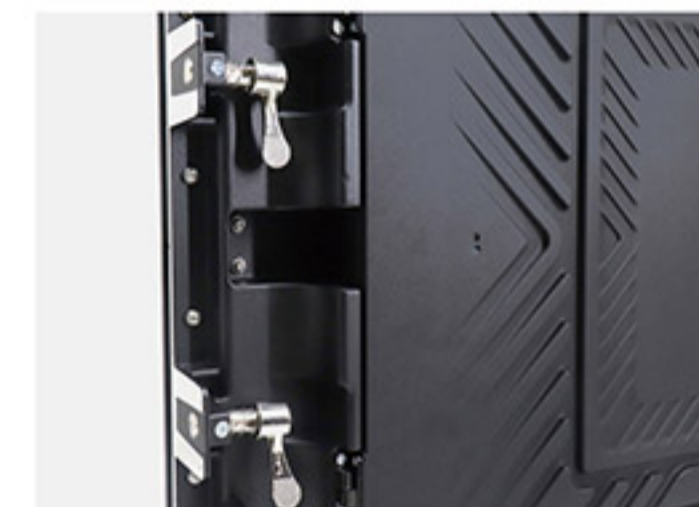

### 03

#### More Cabinet Details

EA640C2 rental LED display pays attention to every detail to ensure a high-quality product experience.



### 04

#### 320x160mm Size LED Modules

EA640C2 LED display is suitable for 320x160mm size LED modules and is easy to assemble and maintain.



# EA500H6

## 500x500mm Rental LED Display

EA500H6 is a high-performance LED rental screen, 500x500mm size, equipped with quick lock and corner protection design, supports front and rear service design, and the power box is removable for easy maintenance. Optional curved locks and beveled cabinets allow for unique installations.

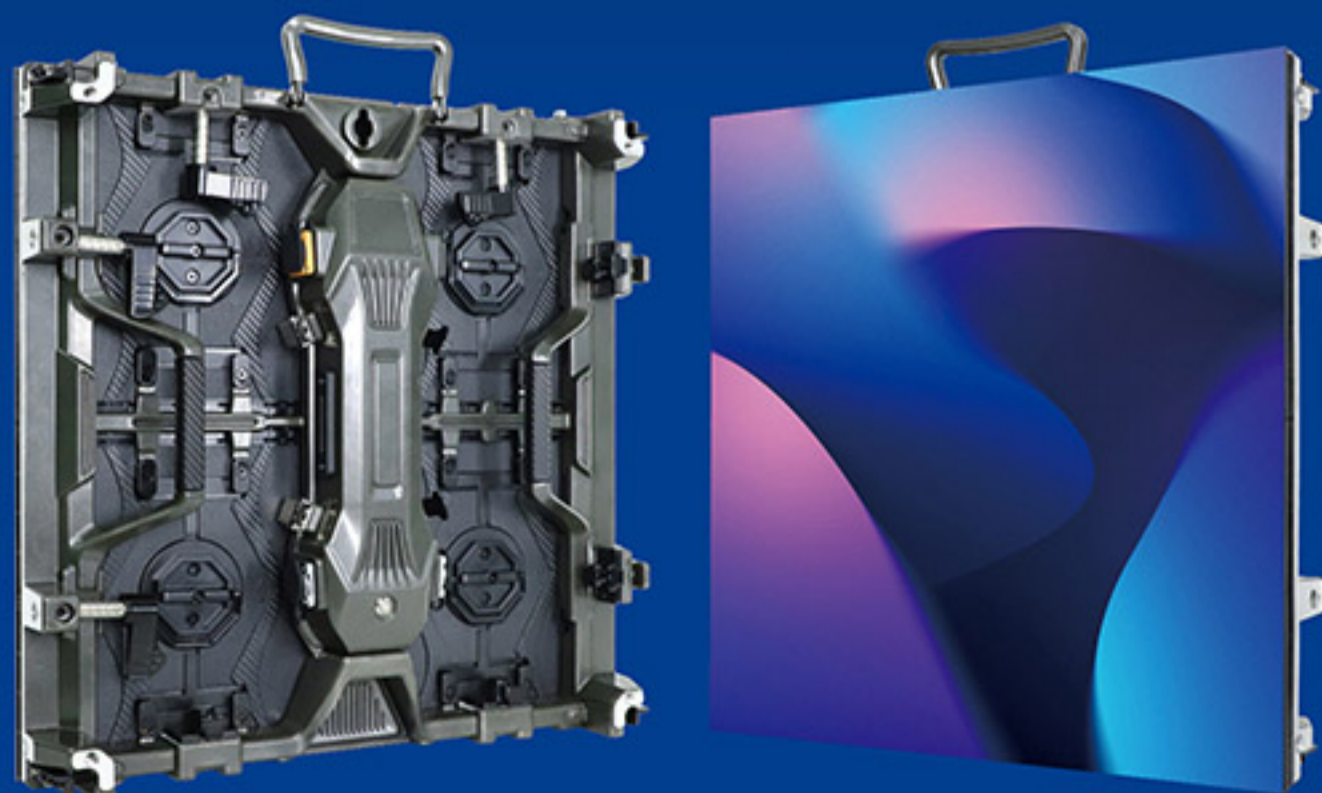

### 01

#### Front and Rear Double Service Design

The LED panel of EA500H6 rental LED display adopts a magnetic design and supports front and rear dual services.



### 02

#### Detachable Power Box

EA500H6 rental LED display adopts Hub connection design, and the power box can be quickly disassembled for easy replacement and maintenance.



### 03

#### Arc Lock(Optional)

EA500H6 LED display screen can be equipped with an arc lock to achieve arc installation.

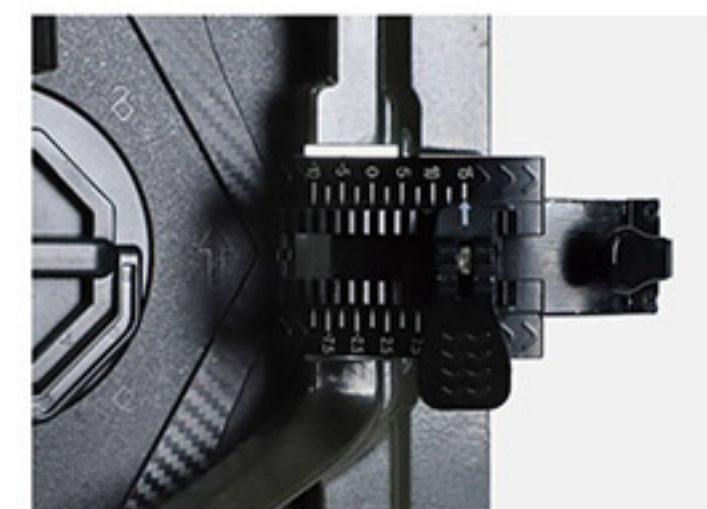

### 04

#### Beveled Cabinet (Optional)

EA500H6 LED display can be optionally equipped with a beveled cabinet to achieve 90-degree installation.

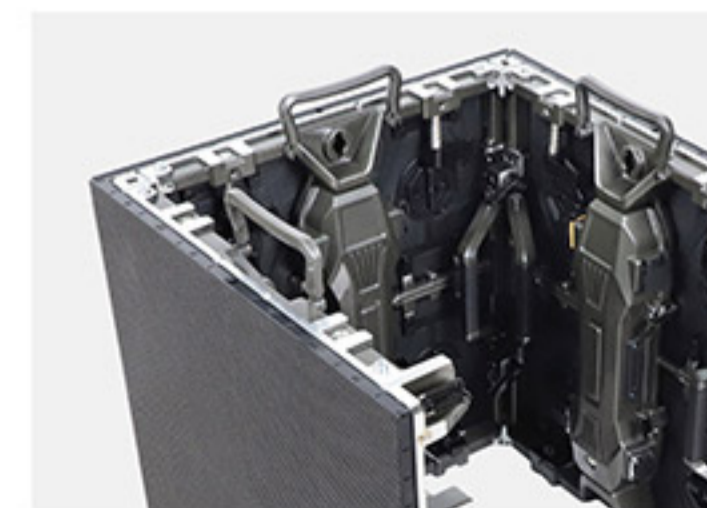



## EA1000H6

### 500x1000mm Rental LED Display

EA1000H6 rental LED display adopts a new design style, equipped with quick lock and corner protection design, supports front and rear service design, and the power box is removable for easy maintenance. Optional curved locks and beveled cabinets allow for unique installations.

#### 01

##### Front and Rear Double Service Design

The LED panel of EA1000H6 rental LED display adopts a magnetic design and supports front and rear dual services.



#### 02

##### Detachable Power Box

EA1000H6 LED display adopts Hub connection design, and the power box can be quickly disassembled for easy replacement and maintenance.



#### 03

##### Arc Lock(Optional)

EA1000H6 rental LED screen can be equipped with an arc lock to achieve arc installation.

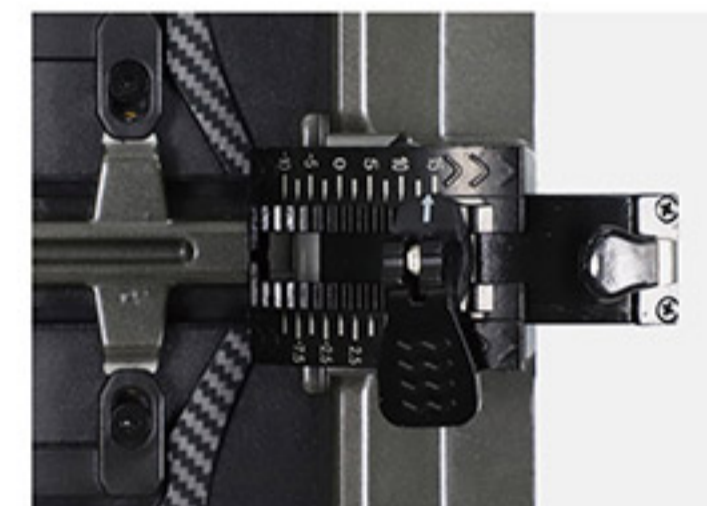

#### 04

##### Beveled Cabinet (Optional)

EA1000H6 LED display screen can be equipped with an angled cabinet to achieve 90-degree installation.





# EA500H7

## 500x500mm Flexible Rental LED Screen

EA500H7 flexible rental LED screen adopts a quick-lock design around it and is made of durable and beautiful materials. It supports inner and outer arc bending installation, which is convenient and fast, and improves the flatness of the picture.

### 01

#### Flexible LED Screen

EA500H7 LED screen uses a dedicated LED module with flexible bending characteristics, which can achieve a variety of special display shapes.



### 02

#### Curved Installation

EA500H7 rental LED screen supports inner arc and outer arc installation.



### 03

#### Curved Shape

EA500H7 rental LED screen supports installation on outer arc and inner arc surfaces, and splicing into cylindrical shapes.

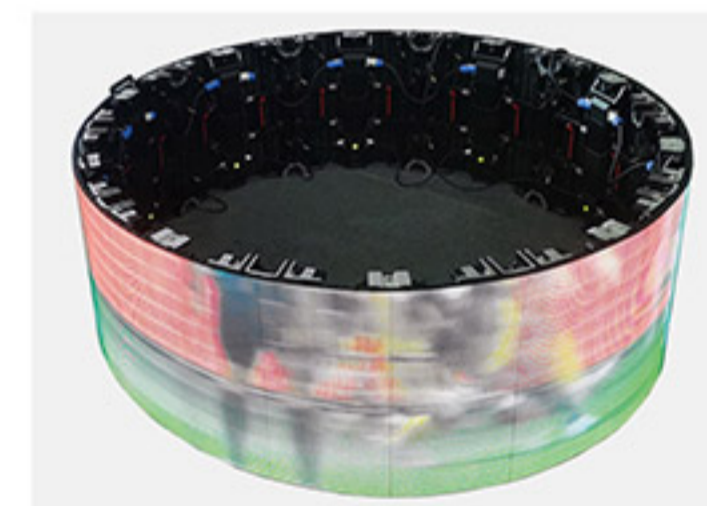

### 04

#### Combined Splicing

EA500H7 can be spliced with EA500H8, EA500H8V, EA1000H8 cabinets on the left and right.





# EA500H8

## 500x500mm Rental LED Display

EA500H8 rental LED display adopts 500x500mm size, equipped with quick lock and corner protection to ensure safety and stability. It has front and rear two-way maintenance function, and the power box is detachable, which greatly improves the convenience of daily maintenance.



### 01

#### Front and Rear Double Service Design

The LED panel of EA500H8 rental LED display adopts a magnetic design and supports front and rear dual services.



### 02

#### Combined Splicing

EA500H8 can be spliced with EA500H7, EA500H8V, EA1000H8 cabinets on the left and right.



### 03

#### Curved installation

EA500H8 LED display can be equipped with curved locks to achieve curved installation. (Optional)



### 04

#### Detachable Power Box

EA500H8 rental LED display adopts HUB connection design, and the power box can be quickly disassembled for easy replacement and maintenance.



# LED DISPLAY INTERNATIONAL EXPO



## EA1000H8

500×1000mm Rental LED Display

EA1000H8 rental LED board adopts a size of 500x1000mm, equipped with quick locks and corner guards to ensure stable installation. Front and rear maintenance, combined with a detachable power box, significantly improves the convenience and efficiency of daily maintenance.

### 01

#### Front and Rear Service

The LED panel of EA1000H8 rental LED display adopts a magnetic design and supports front and rear dual services.



### 02

#### Combined Splicing

EA1000H8 can be spliced with EA500H7, EA500H8V, EA500H8 cabinets on the left and right.



### 03

#### Curved installation

EA1000H8 LED screen can be equipped with curved locks to achieve curved installation. (Optional)



### 04

#### Detachable Power Box

EA1000H8 rental LED display adopts HUB connection design, and the power box can be quickly disassembled for easy replacement and maintenance.





## EA500H8V

### 500x500mm Rental LED Display

EA500H8V right-angle rental LED screen adopts 45-degree bevel cabinet design, supports right-angle splicing, and supports front and back two-way maintenance. Equipped with quick lock and arc lock, it perfectly meets the diverse needs of the rental market.



#### 01

##### 45° Beveled LED Cabinet

EA500H8V series is designed for the rental market with a specially designed 45-degree angle cabinet.



#### 02

##### Combined Splicing

EA500H8V can be spliced with EA500H7, EA500H8, EA1000H8 cabinets on the left and right.



#### 03

##### Front and Rear Service

EA500C5 LED display can be equipped with curved locks to achieve curved installation.



#### 04

##### Multiple Splicing Methods

EA500H8V rental LED screen combines an arc-shaped lock design to achieve arc splicing, plane splicing, and right-angle splicing.

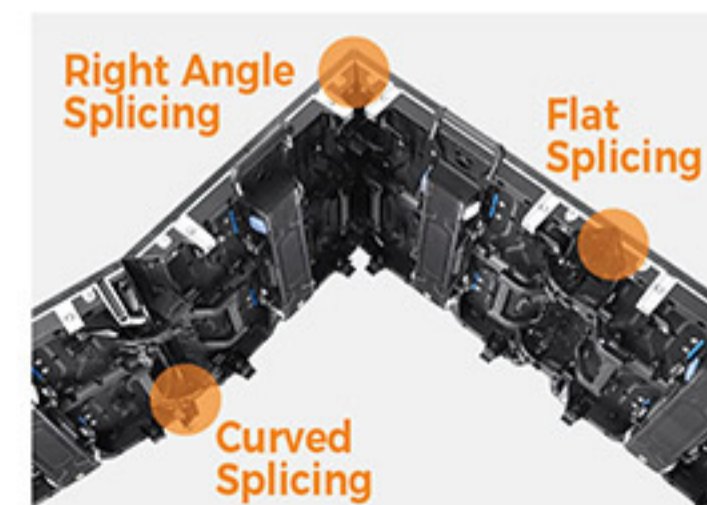

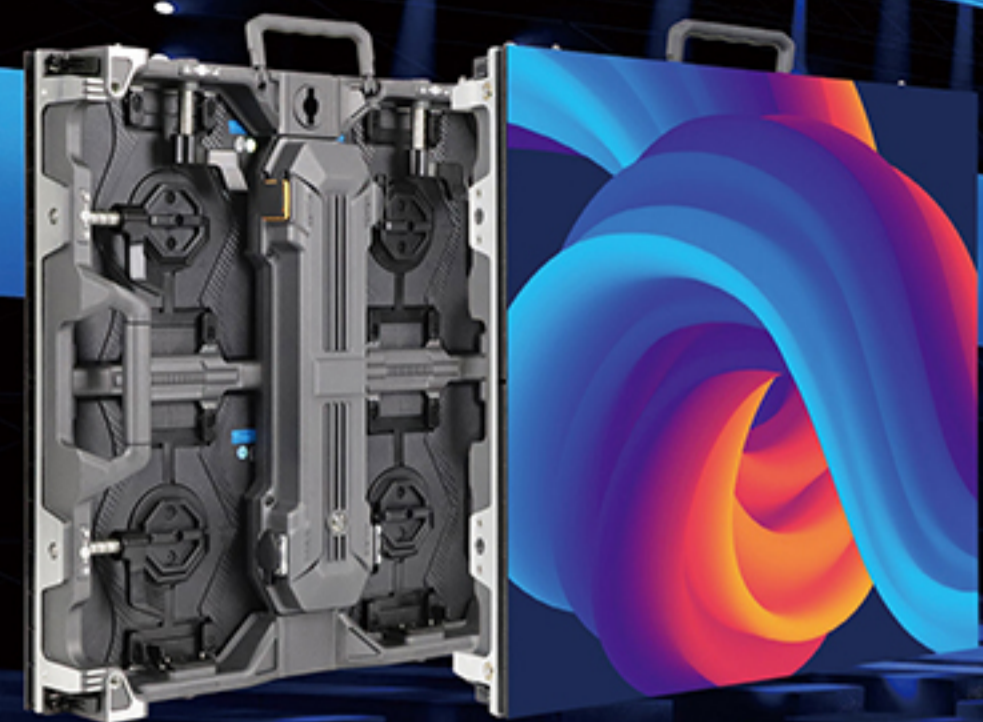

# CITY EXHIBITION

## EA500H9 500x500mm Rental LED Display

EA500H9 rental LED board, 500x500mm size, equipped with quick lock and corner protection design, supports front and back maintenance, and the power box is removable for easy maintenance. Optional arc lock helps to create a unique installation effect.

### 01

#### Front and Rear Service

EA500H9 series LED display adopts Magnet Adsorption LED Panel to make the cabinet is accessed with frontal and rear design.



### 03

#### Splicing EA1000H9 Cabinet

EA500H9 rental LED board can be connected with EA1000H9 rental LED board in left and right and up and down directions.

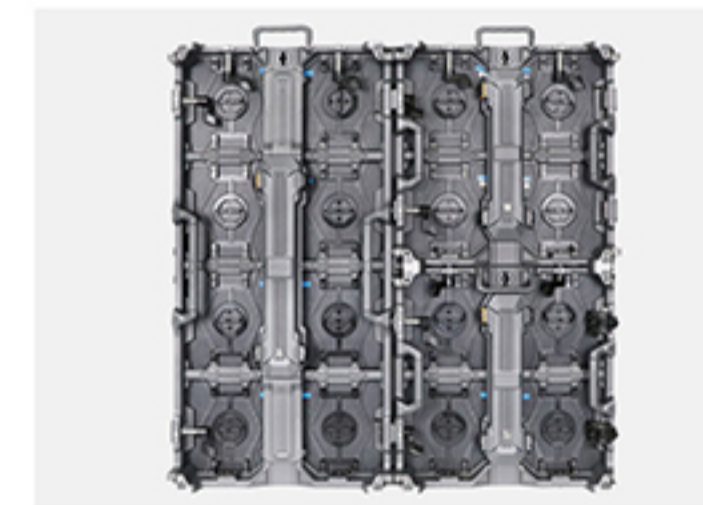

### 02

#### High Precision Curve Lock

EA500H9 rental LED board can be equipped with high-precision arc locks to easily achieve arc installation.



### 04

#### Power Box Design

The LED power box adopts a screw fastening design, has excellent sealing performance, and a higher waterproof level, ensuring stable operation of the equipment.

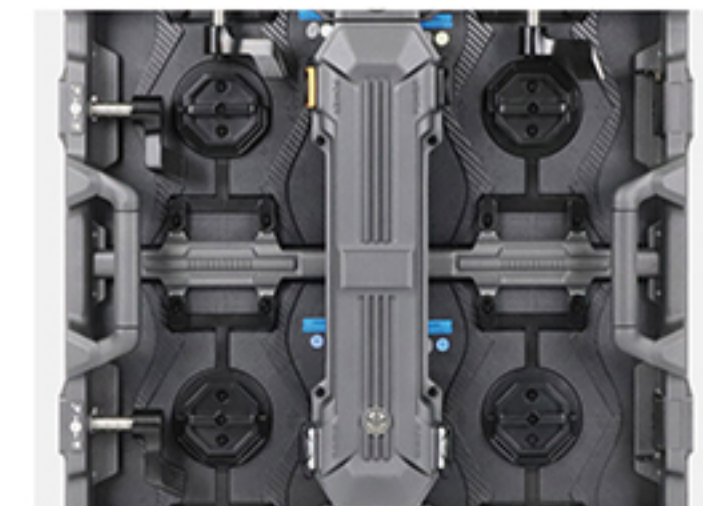





## EA1000H9

### 500x1000mm Rental LED Display

EA1000H9 rental LED wall, size 500x1000mm, equipped with quick lock and corner protection design, supports front and back maintenance, power box can be disassembled, maintenance is convenient. Optional arc lock, easy to achieve unique installation effect.

#### 01

##### Front and Rear Service

EA1000H9 LED screen innovatively uses magnetic adsorption LED panels, and the cabinet design supports front and rear maintenance.



#### 02

##### High Precision Curve Lock

EA1000H9 LED display can be equipped with curved locks to achieve curved installation.



#### 03

##### Splicing EA500H9 Cabinet

EA1000H9 series and EA500H9 series support splicing installation of top, bottom, left and right.

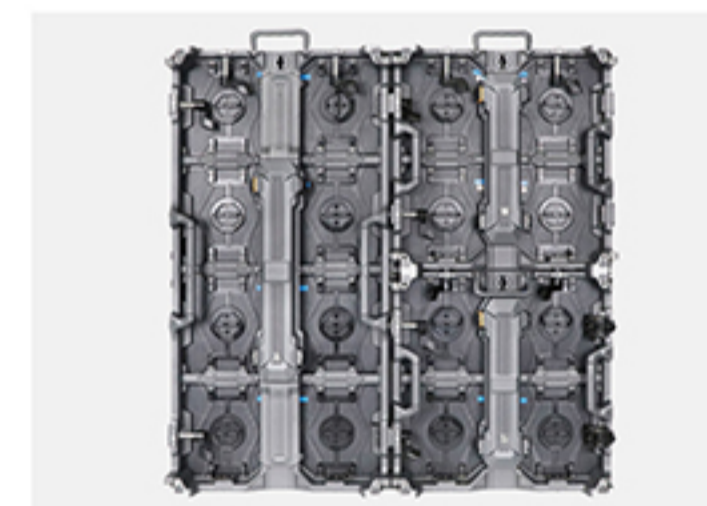

#### 04

##### Power Box Design

The LED power box adopts a screw fastening design, has excellent sealing performance, and a higher waterproof level, ensuring stable operation of the equipment.





# EA576H1

## 576×576mm Rental LED Display

EA576H1 outdoor rental LED screen has a size of 576x576mm, a compact design, quick locks and corner protectors, supports front and back service, and a detachable power box, greatly facilitating daily maintenance and operation.



### 01

#### Front and Rear Service

EA576H1 LED screen innovatively uses magnetic adsorption LED panels, and the cabinet design supports front and rear maintenance.



### 02

#### Detachable Back Cover

EA576H1 outdoor rental LED screen adopts a Hub connection design, and the power box supports disassembly.



### 03

#### Curved installation

EA576H1 LED screen can be equipped with high-precision arc locks to achieve arc installation. (Optional)



### 04

#### 288x288mm Size LED Modules

EA576H1 LED display is suitable for 288x288mm size LED modules and is easy to assemble and maintain.



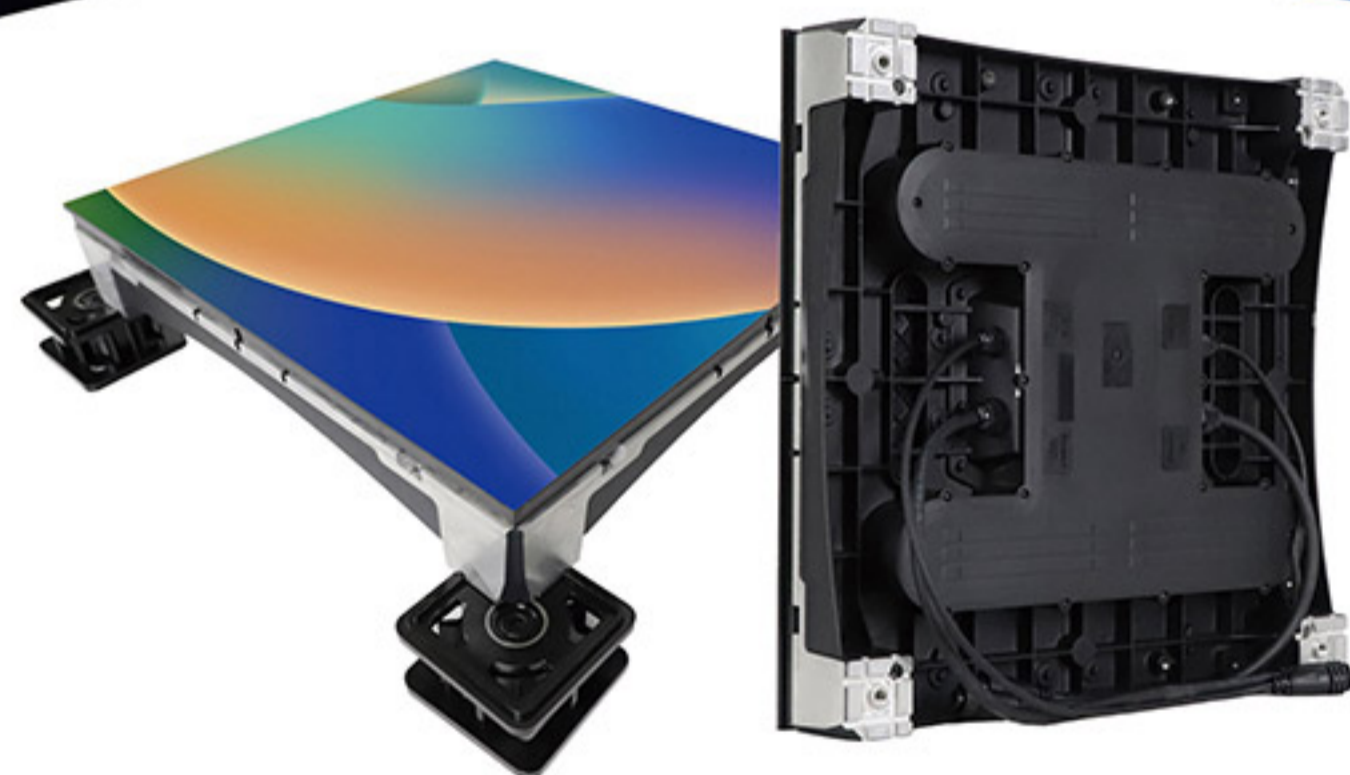
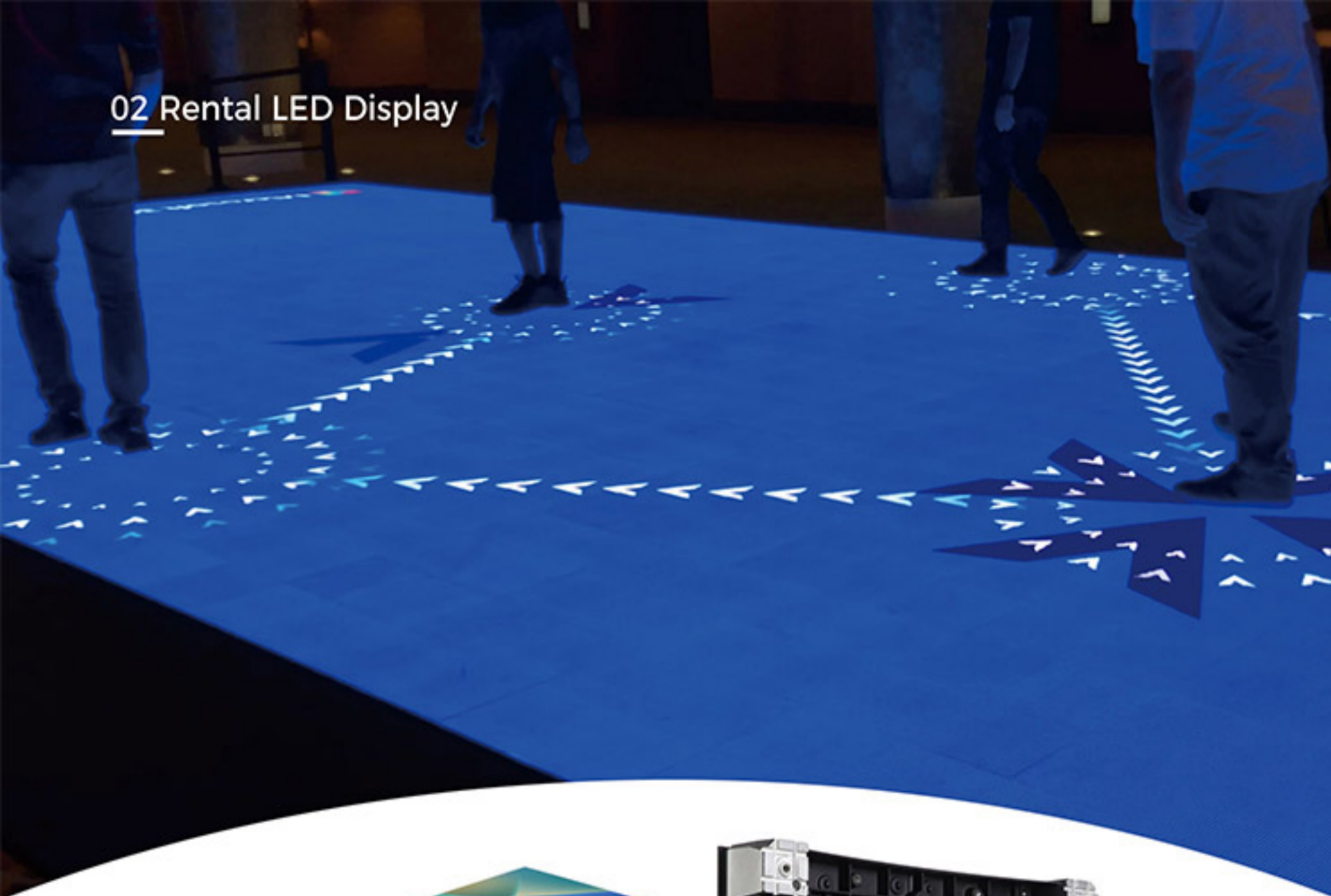

## EA500RF

### Indoor Rental LED Floor Display

EA500RF indoor rental floor LED screen is particularly suitable for stage, exhibition, conference and other places. Compared with traditional LED floor tile screen, EA500RF is very easy to install and disassemble, suitable for various temporary occasions.

#### 01

##### Easy Installation

By fixing it with the ground feet, users can quickly complete the installation of the EA500RF floor tile screen, which is suitable for short-term activities.



#### 02

##### Front Service

EA500RF indoor LED rental floor display supports front service and uses vacuum suction cup technology for maintenance.



#### 03

##### High Load-bearing

To ensure the proper functioning of the display equipment, the LED panel can withstand over 1,000KG/m<sup>2</sup>.



#### 04

##### Interactive Induction (Optional)

EA500RF LED screen can be equipped with optional sensing chip, which supports real-time image sensing effect when human body touches.





COMMERCIAL  
ADVERTISING

# EA250F

## Outdoor Front Service LED Display

EA250F LED display uses front service 250x250mm LED modules and is equipped with an IP65 waterproof design, making it an ideal outdoor LED display. This series of LED displays provides a variety of size customization options, you can choose the appropriate size according to your needs.

1000x1000mm

500x1000mm

1000x500mm



### 01

#### Outdoor Full Frontal Service

EA250F LED display adopts front service design, saving time and labor on site.

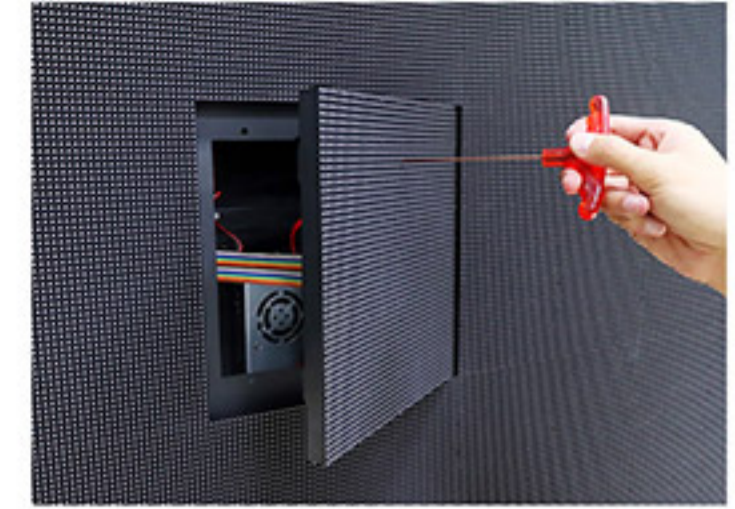

### 02

#### High Efficiency Cooling

EA250F LED display is equipped with 4 wing fans for quick heat dissipation.



### 03

#### All Weather Outdoor Work

EA250F LED display can work normally at temperatures ranging from -20°C to 60°C, durable and reliable.



### 04

#### 250x250mm Size Modules

EA250F LED display is suitable for 250x250mm size LED modules and is easy to assemble and maintain.





# EA320F

## Outdoor Front Service LED Display

EA320F LED display uses front service 320x320mm LED modules and is equipped with an IP65 waterproof design, making it an ideal outdoor LED display. Its advanced technology also ensures that it is an excellent solution for high-end commercial screens.



### 01

#### Outdoor Full Frontal Service

EA320F LED display adopts front service design, saving time and labor on site.



### 02

#### High Efficiency Cooling

EA320F LED display is equipped with 3 wing fans for quick heat dissipation.



### 03

#### All Weather Outdoor Work

EA320F LED display can work normally at temperatures ranging from -20°C to 60°C, durable and reliable.



### 04

#### 320x320mm Size LED Modules

EA320F LED display is suitable for 320x320mm size LED modules and is easy to assemble and maintain.





## EA960R3

### 960x960mm Rear Service LED Display

EA960R3 LED display measures 960mm x 960mm and uses 320x160mm modules. This LED display can be used for both indoor and outdoor applications, including fixed installations and rentals.

#### 01

##### Rear Service Design

The back cover of EA960R3 LED display can be quickly opened for maintenance.



#### 02

##### High Efficiency Cooling

EA960R3 LED display is equipped with 4 wing fans on the back cover for quick heat dissipation.



#### 03

##### Fast Locks

Multiple quick locks on the LED display screen make it easy to assemble and ensure that the screen is installed flat.



#### 04

##### Hidden Line Design Between Cabinets

Cables between cabinets are connected through holes on the sides of the cabinets.





## EA960R4

### 960x960mm Rear Service LED Display

EA960R4 LED Display Billboard uses a 960mm x 960mm magnesium alloy cabinet design, which is sturdy, durable and supports post-maintenance. The display is suitable for indoor and outdoor fixed installation and rental applications.

#### 01

##### Rear Service Design

The back cover of EA960R4 LED display can be quickly opened for maintenance.



#### 02

##### High Efficiency Cooling

EA960R4 LED display is equipped with 2 wing fans on the back cover for quick heat dissipation.



#### 03

##### Fast Locks

Multiple quick locks on the LED display screen make it easy to assemble and ensure that the screen is installed flat.



#### 04

##### Hidden Line Design Between Cabinets

Cables between cabinets are connected through holes on the sides of the cabinets.





# EA1280R1

## 1280x960mm Rear Service LED Display

EA1280R1 LED display cabinet is made of magnesium alloy, which is strong and durable. This LED display is available for indoor and outdoor applications, including fixed installation and rental.



### 01

#### Rear Service Design

The back cover of EA1280R1 LED display can be quickly opened for maintenance.

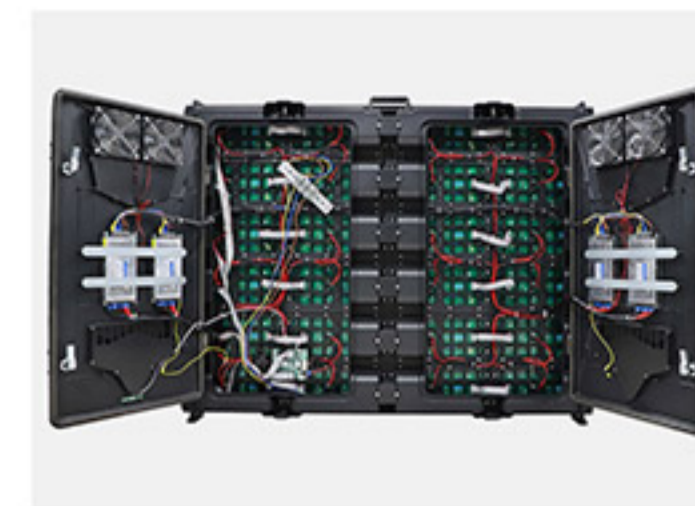

### 02

#### High Efficiency Cooling

EA1280R1 LED display is equipped with 4 wing fans on the back cover for quick heat dissipation.



### 03

#### Fast Locks

Multiple quick locks on the LED display screen make it easy to assemble and ensure that the screen is installed flat.



### 04

#### Hidden Line Design Between Cabinets

Cables between cabinets are connected through holes on the sides of the cabinets.







## EA960F3

### Outdoor Energy-saving LED Display

EA960F3 series is a new generation of fixed outdoor LED billboard, with aluminum cabinet, size of 960\*960mm, equipped with high protection panel design, protection level up to IP65. Support front and back dual business, easy maintenance. Ultra-low heat and power consumption, providing excellent visual experience.

#### 01

##### Front and Rear Dual Service

Thanks to its front and rear service mode, the LED panel can be assembled, saving your maintenance cost.



#### 02

##### Safety Line Design

Each LED module is equipped with a safety harness to prevent any chance of the module falling.



#### 03

##### Elegant Design

The power line and data line of the LED display are hidden at the bottom of the panel.



#### 04

##### 90° Arc Cabinet

EA960F3 series can be customized with a 90° curved cabinet, which supports arc corner splicing and realizes naked-eye 3D screen.



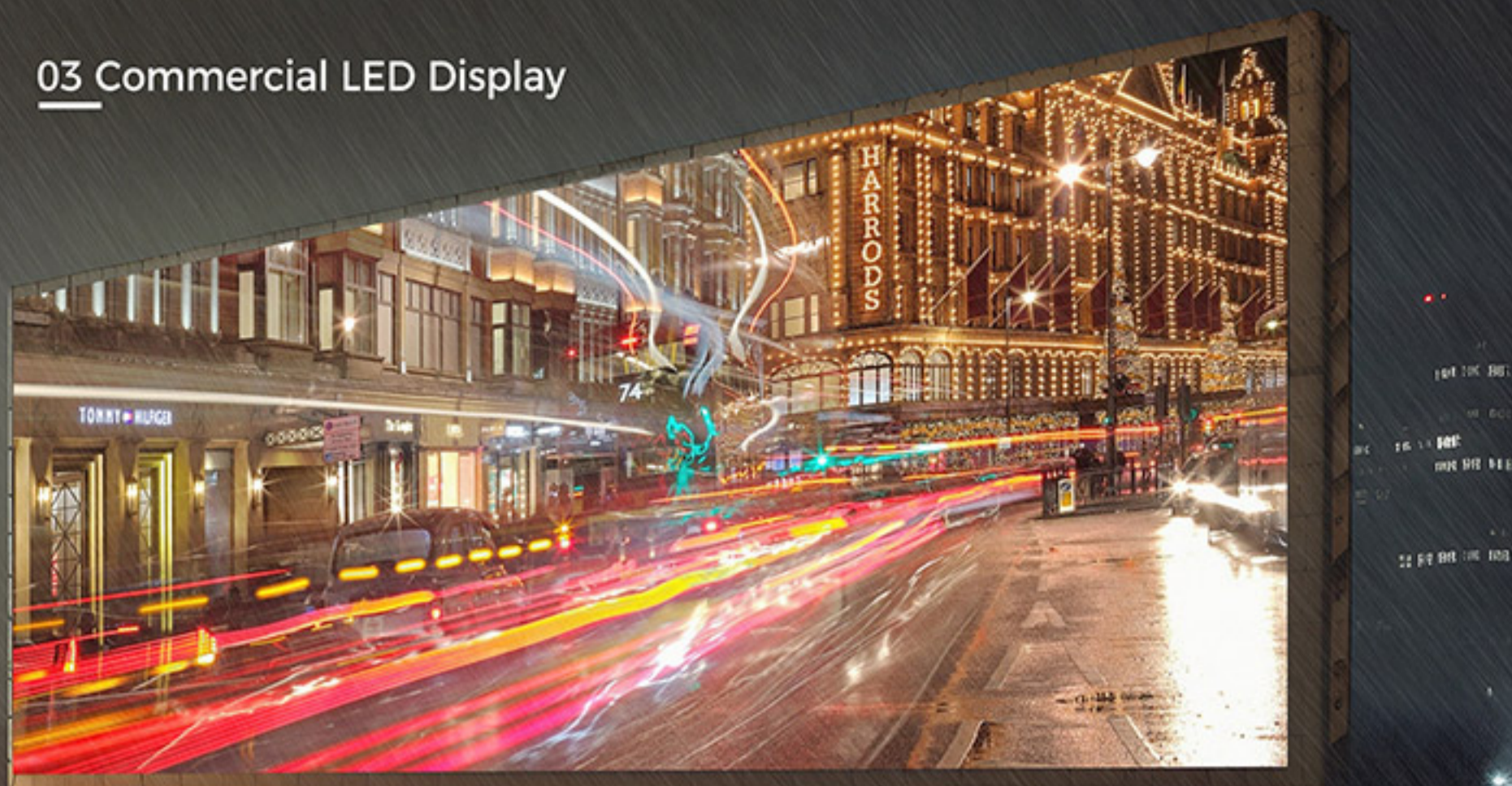

## EA960D1

### 960x960mm Dual Service LED Display

EA960D1 outdoor commercial LED display supports front and rear dual maintenance, making it convenient for users to perform quick maintenance. The display is made of die-cast magnesium and measures 960x960mm, giving you an excellent visual experience.

#### 01

##### Dual Service Design

Dual service mode of front and rear design to save you Maintenance Cost.



#### 02

##### Openable Back Cover

The back cover of EA960D1 LED display can be quickly opened for maintenance.



#### 03

##### High Efficiency Cooling

EA960D1 LED display is equipped with 4 wing fans on the back cover for quick heat dissipation.



#### 04

##### Delicate Cabinet Design

Equipped with aviation plug to ensure stable connection, equipped with quick lock and handle for easy installation.





## EA-OFixed

### Outdoor Fixed Installation LED Display

EA-OFixed outdoor LED screen adopts SMD LED technology with high color uniformity and brightness. Featuring an IP65 rating and ultra-wide viewing angles, the screen is easy to install and comes in a range of standard sizes.



512x512

576x576

640x640

768x768

960x960

1024x768

1024x1024

1280x960

Various sizes of LED display for customers to choose

#### 01

##### Customized Cabinets

EA-OFixed series LED screen support customization of flip iron boxes, lamp pole screens, and advertising machines, with flexible and optional sizes.



#### 02

##### High Efficiency Cooling

EA-OFixed LED display is equipped with 4 wing fans on the back cover for quick heat dissipation.

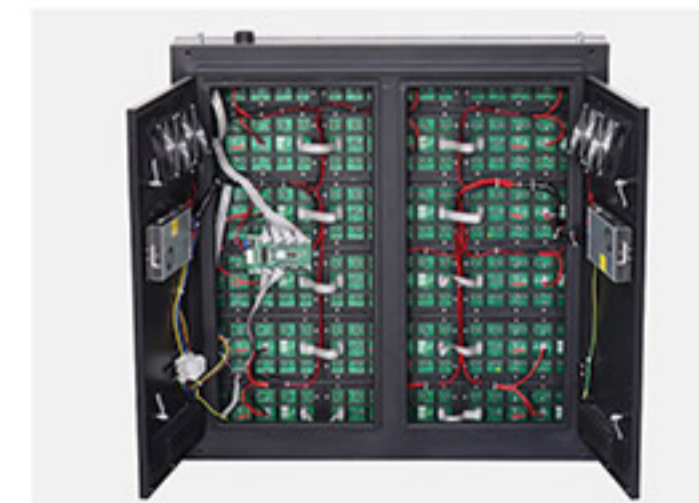

#### 03

##### Rugged Cabinet

EA-OFixed LED display cabinet is crafted from high-hardness iron material, delivering excellent performance.



#### 04

##### 90° Curved Display (optional)

EA-OFixed LED screen can be installed in a 640x960mm curved cabinet to achieve a 90° curved installation.

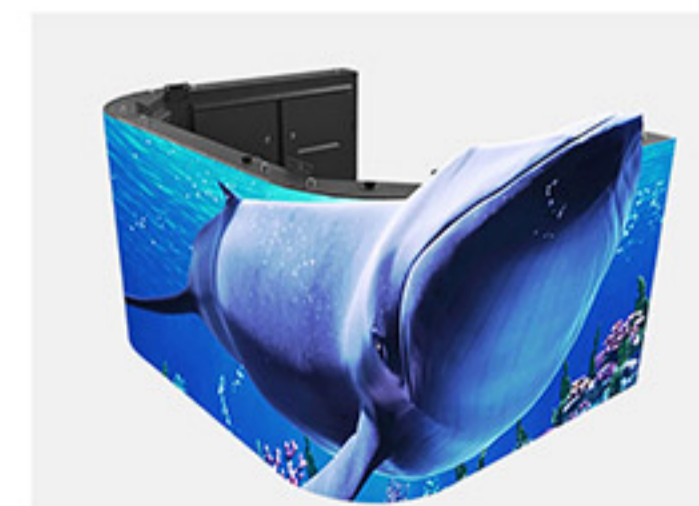



# EA-iFloor

## Indoor Floor LED Display

EA-iFloor LED display is a unique LED display, you only need to place the floor tile LED display flat on the ground and fix it to complete the splicing. In addition, it also has the advantages of high definition, IP65 waterproof and dustproof, and is suitable for various indoor commercial places.

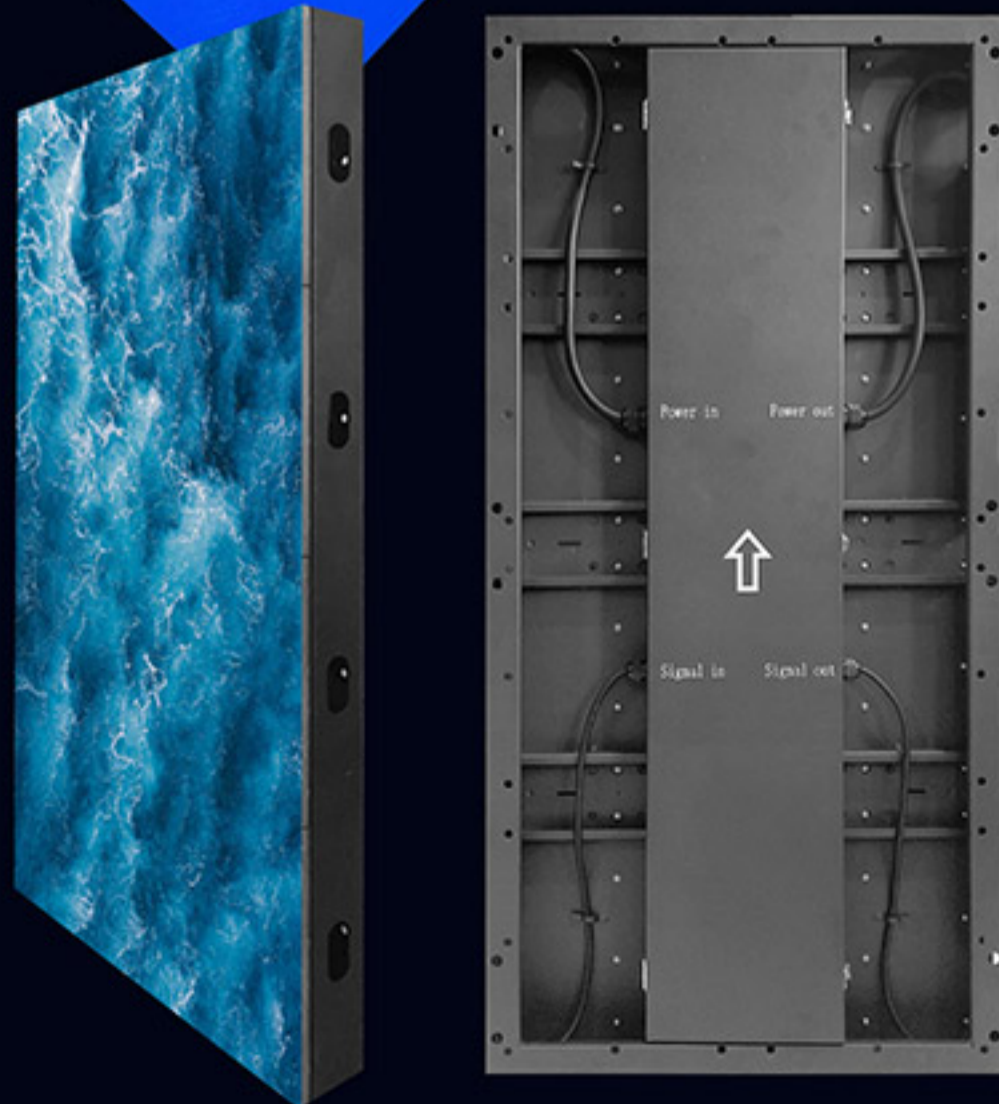

### 01

#### Easy Installation

EA-iFloor LED display supports a variety of installation methods, including ground installation, embedded installation, and rail installation.



### 02

#### Front Service

EA-iFloor LED display adopts a magnetic front maintenance design, which will save you time and energy, and complete maintenance easily.

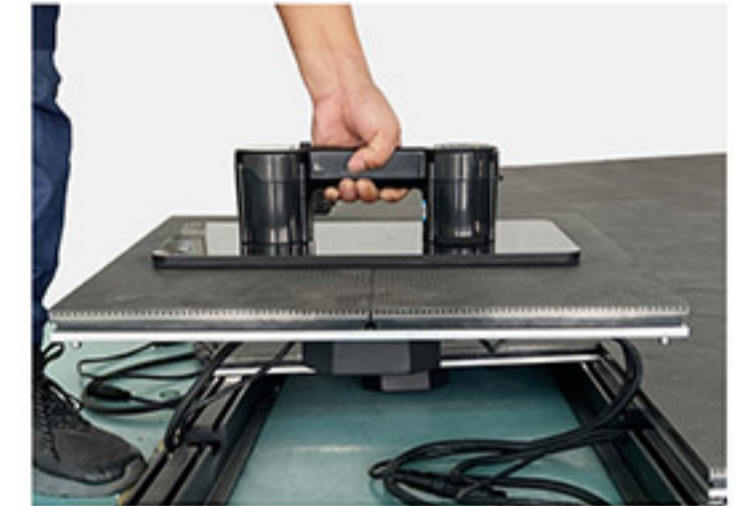

### 03

#### Strong Load-bearing Performance

To ensure the proper functioning of the display equipment, the LED panel can withstand over 2,000KG/m<sup>2</sup>.

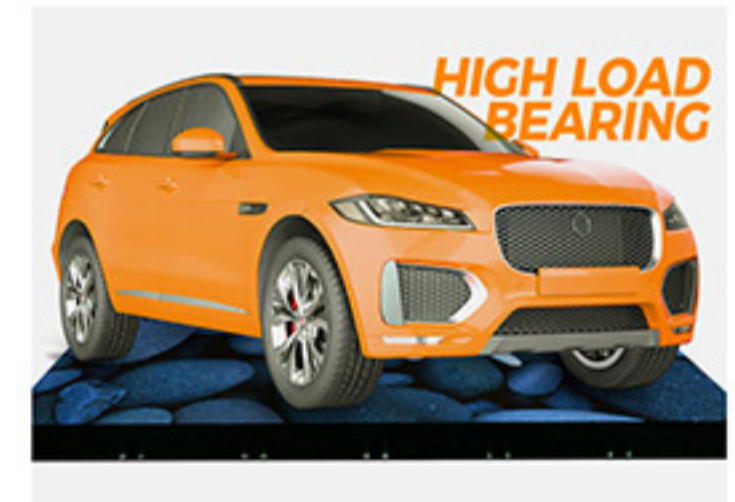

### 04

#### 250x250mm Size Module with Anti-scratch Mask

The LED module mask is wear-resistant and scratch-resistant, and is equipped with a waterproof rubber ring.

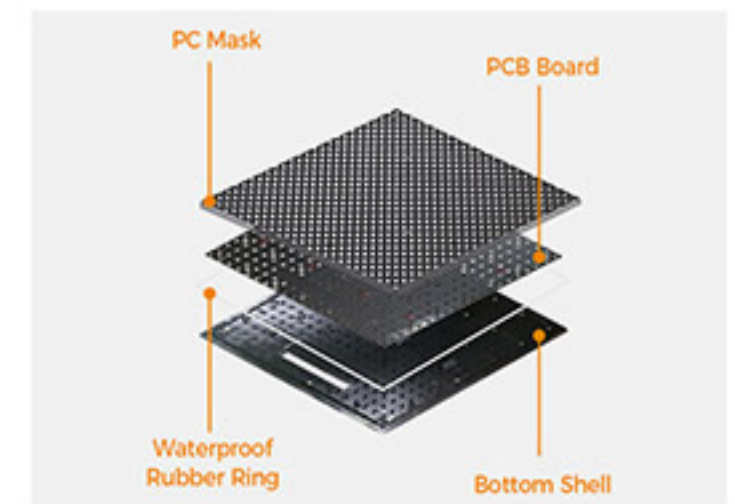



# EA-OFloor

## Outdoor Floor LED Display

EagerLED outdoor floor LED display adopts special designs in terms of load-bearing, protective performance, and heat dissipation performance. The front and rear protection level reaches IP68, and the floor tile screen can operate stably outdoors for a long time.

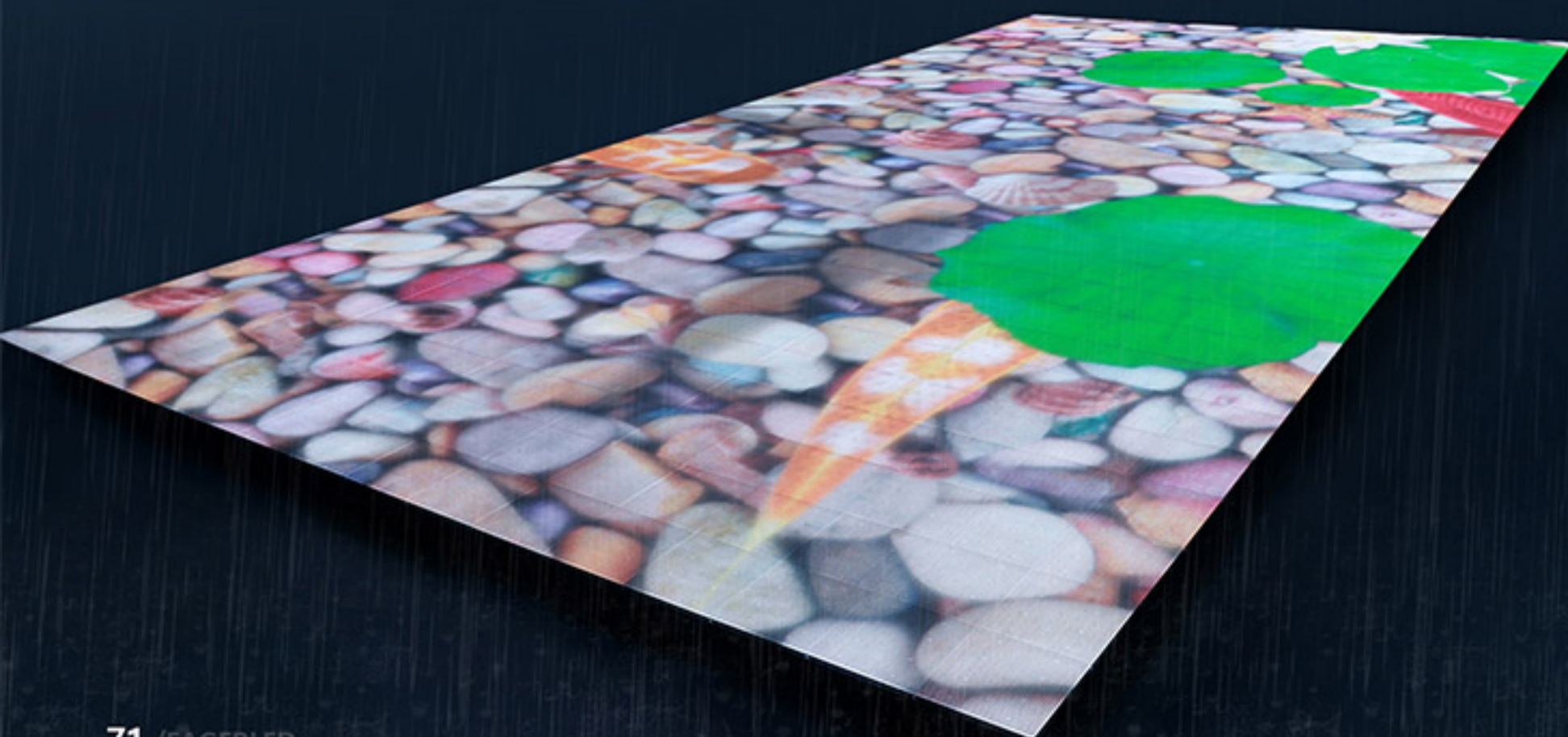

### 01

#### Easy Installation

EA-OFloor LED display supports a variety of installation methods, including ground installation, and fixed on the wall (LED wall).



### 02

#### Front Service

EA-OFloor LED display adopts a magnetic front maintenance design, which will save you time and energy, and complete maintenance easily.



### 03

#### Strong Load-bearing Performance

To ensure the proper functioning of the display equipment, the LED panel can withstand over 1,500KG/m<sup>2</sup>.



### 04

#### 250x250mm Size Module with Anti-scratch Mask

The LED module mask is wear-resistant and scratch-resistant, and is equipped with a waterproof rubber ring.

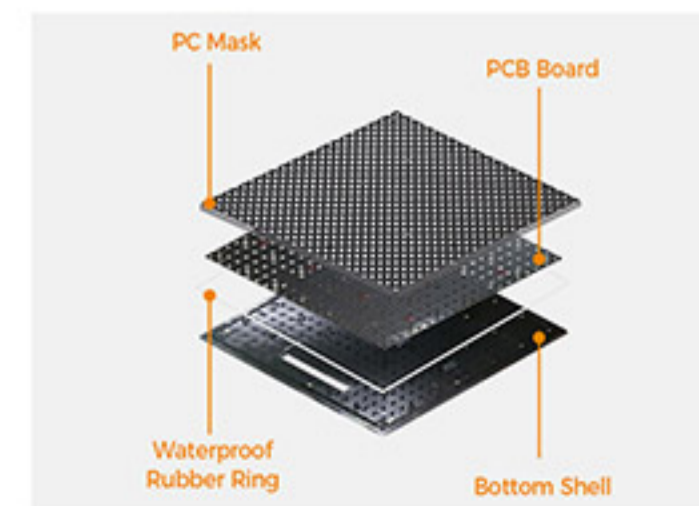



# EA-Flex

Indoor Soft Flexible LED Display

Compared to traditional rigid LED display module, our flexible LED display module is soft and flexible. You can use our flexible LED modules to build creative LED screens of many shapes.



Curvature  $\leq 45^\circ$



Magnetic Front Service



Support Quick Install



140° Wide Viewing Angle

## 01

### Ultra-light Flexible LED Display Module

The flexible module adopts a flexible material circuit board, which can customize various screen shapes at will.



## 02

### Easy Installtion Magnetic Front Service

Magnetic connection, easy assemble and disassemble with soft LED display panel directly.

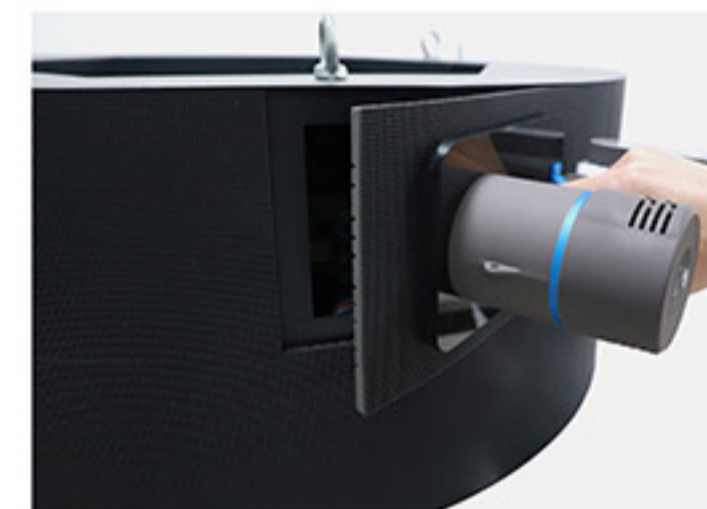

## 03

### Customized Shape, Wide Application

EagerLED flexible LED sign can be customized any shape as customer's need, can be used in various fields and applications, such as shopping center, mall, disco, bar, stage, television, exhibition, show.



04 Flexible LED Display



Magnetic Front Service



Plug and Play Design

## EA-DCan

### Indoor Can LED Screen

EA-DCan indoor can LED screen is an innovative LED display that perfectly restores the bottle shape of a beer can and presents it in a 1:1 ratio. It is both visually impactful and creative. It can flexibly replace text or video content, helping brand stores break the conventional impression and attract more consumers' attention.

#### 01

##### Flexible LED Module

Flexible LED technology enables the LED can screen to have an ultra-wide viewing angle and excellent surface flatness when used indoors.



#### 02

##### Front Service

EA-DCan indoor can LED screen can conveniently maintain the LED module from the front.

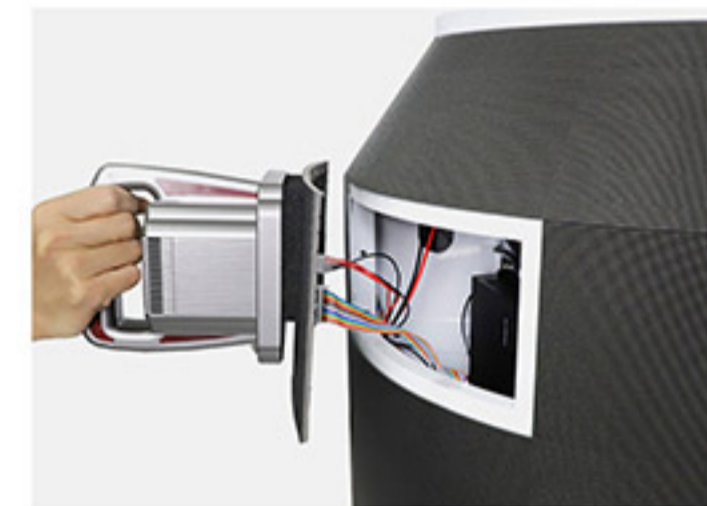

#### 03

##### Move with Wheels

EA-DCan LED screen base is equipped with three high-quality wheels for easy and flexible movement.



#### 04

##### Plug and Play

EA-DCan indoor LED screen adopts plug-and-play design, easy to use and quick to start.

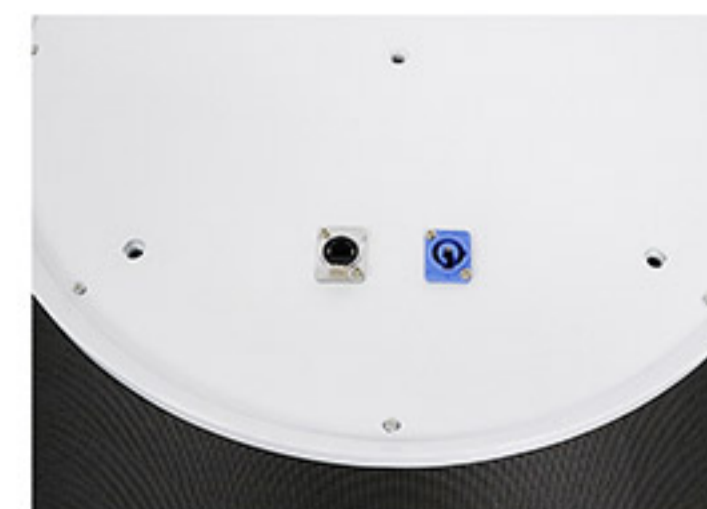

# EA1000TOR

## Outdoor Rental Transparent LED Display

EA1000TOR transparent LED screen is a slim and strong LED display with high light transmittance, and its light transmittance is as high as 65%. The LED display has a high degree of protection IP65, easy to install, and supports front and rear services.

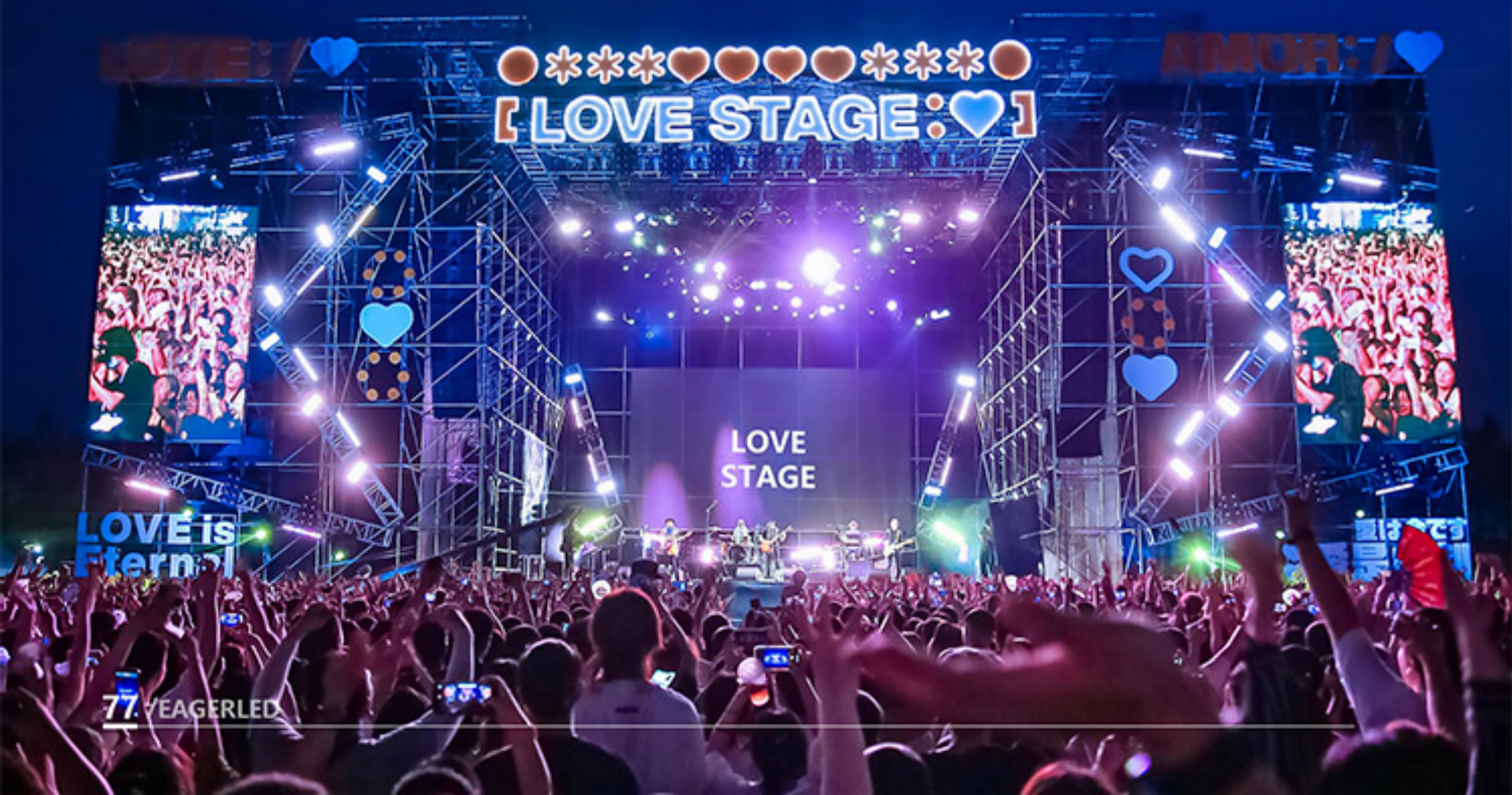
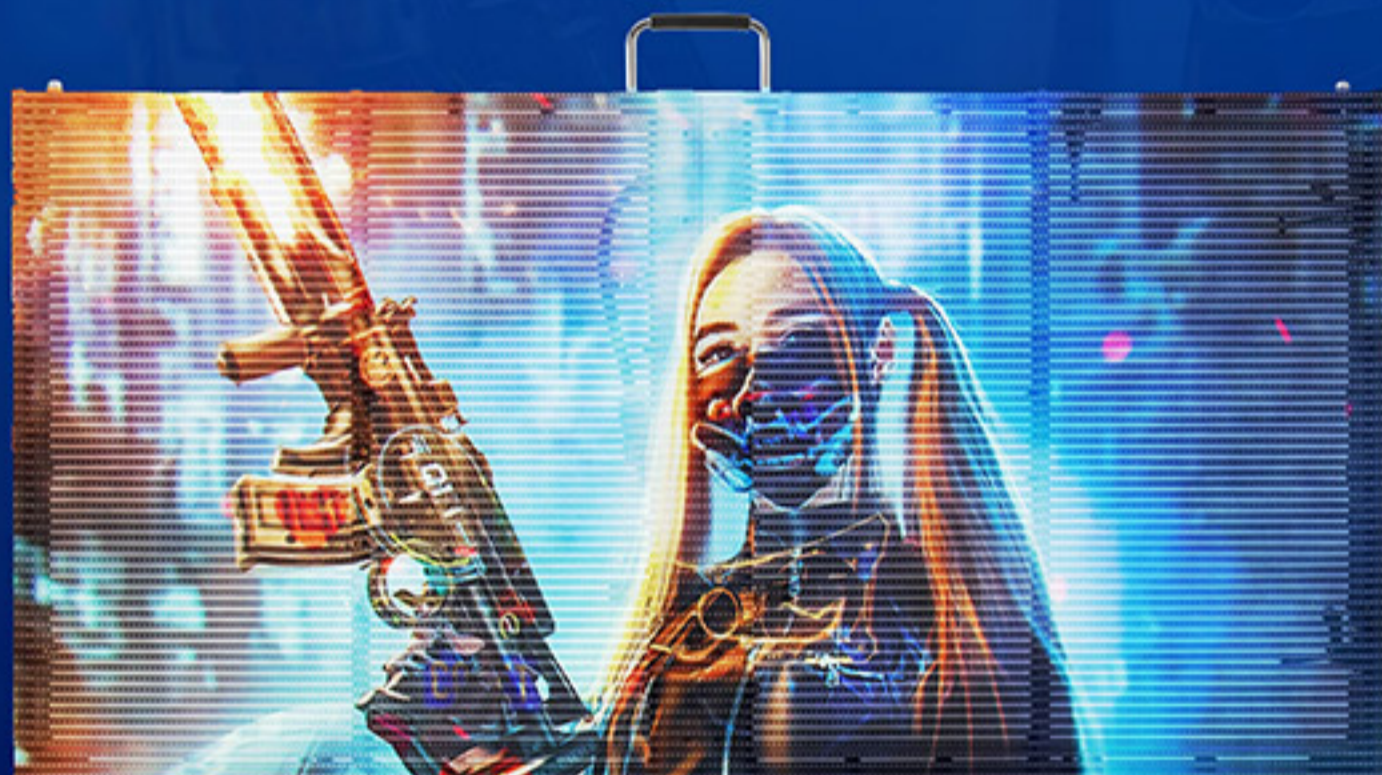

### 01

#### High Transparency

The transparency of EA1000TOR LED display is as high as 70%, which greatly reduces wind resistance.



### 02

#### IP65 Dustproof and Waterproof

EA1000TOR LED display is specially designed for outdoor applications, providing exceptional protection with its high level of IP65.



### 03

#### 500\*500mm Bevel Cabinet (Optional)

Choose 500x500mm beveled cabinets, which can be spliced into right angles.



### 04

#### Spliced Square Column Screen

500x500mm angled cabinets and 500x1000mm cabinet bodies can be freely connected.





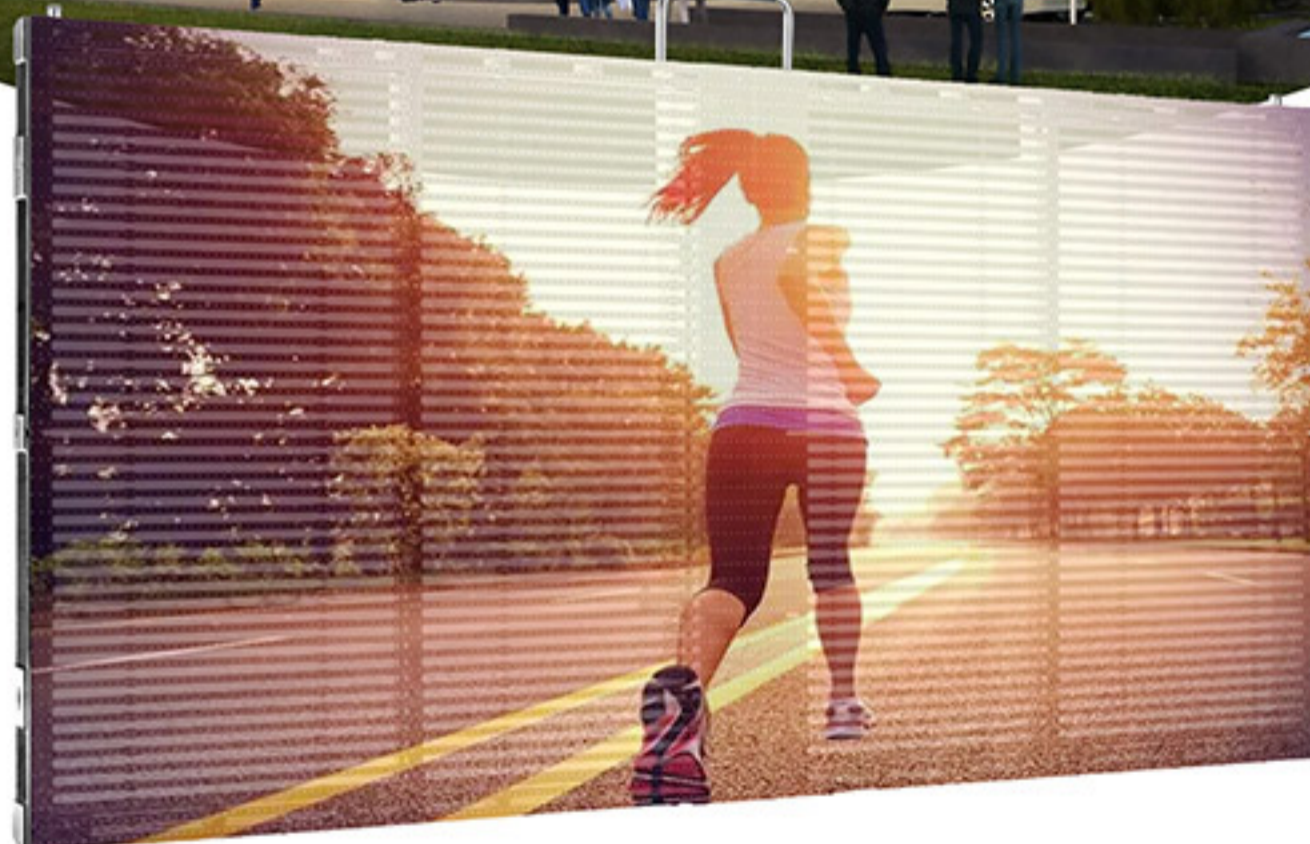

## EA1000TOF

### Outdoor Fixed Installation Transparent LED Display

The transparency of EA1000TOF LED screen can reach 70%. Its LED lights and PCB are fully sealed with silicone, and the protection level reaches IP65. In addition, the LED screen supports front-end and back-end services, and is easy to install and maintain.

#### 01

##### High Transparency

The transparency of EA1000TOF LED display is as high as 70%, which greatly reduces wind resistance.



#### 02

##### IP65 Dustproof and Waterproof

EA1000TOF LED display is specially designed for outdoor applications, providing exceptional protection with its high level of IP65.



#### 03

##### Easy to Install

EA1000TOF LED display supports stacking installation, hanging installation and fixed installation.

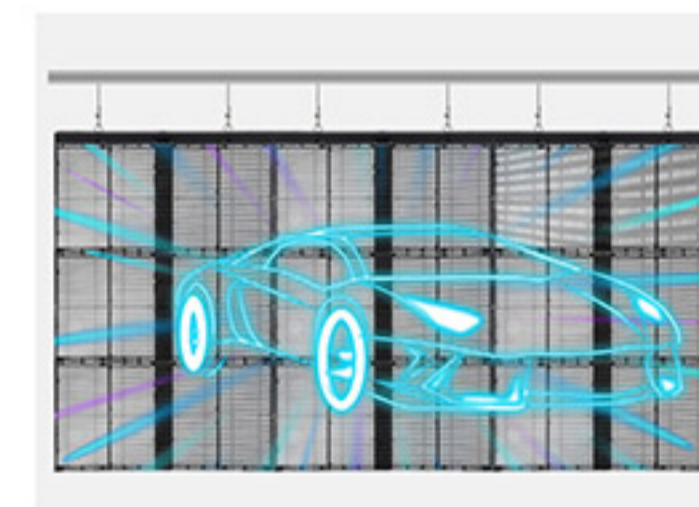

#### 04

##### 500x250mm Size LED Modules

EA1000TOF LED display is suitable for 500x250mm size LED modules and is easy to assemble and maintain.

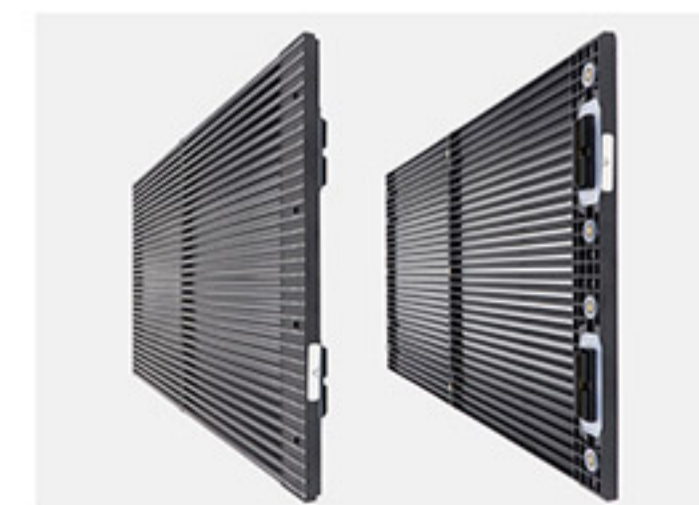



## EA1000TiR

### Indoor Rental Transparent LED Display

EA1000TiR LED screen transparency can reach 70%, ultra-thin and ultra-light structure design, easy installation and disassembly. In addition, the new structural design meets the requirements of various rental activities.

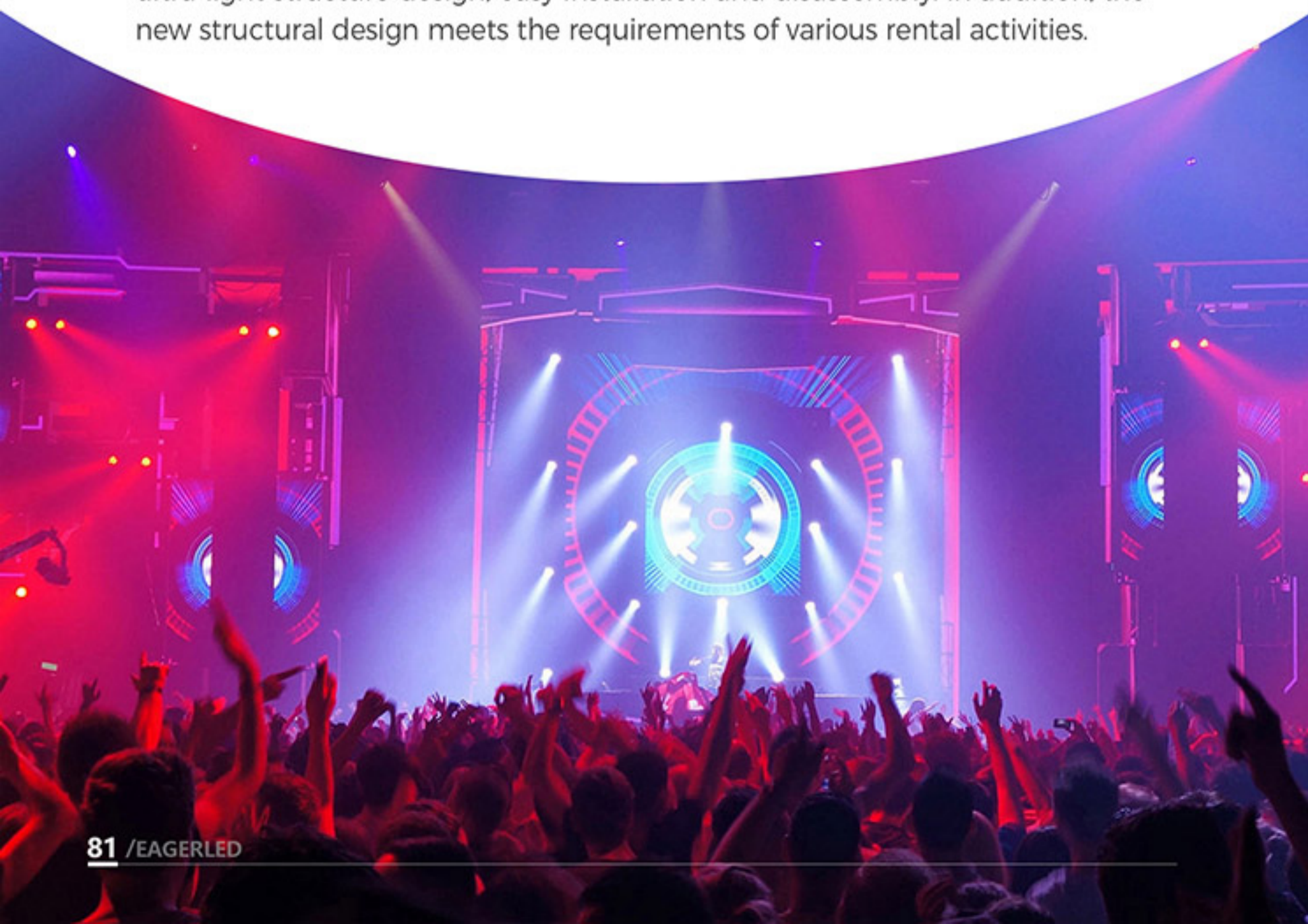

#### 01

##### High Transparency

The transparency of this LED display is as high as 80%, which greatly reduces wind resistance.

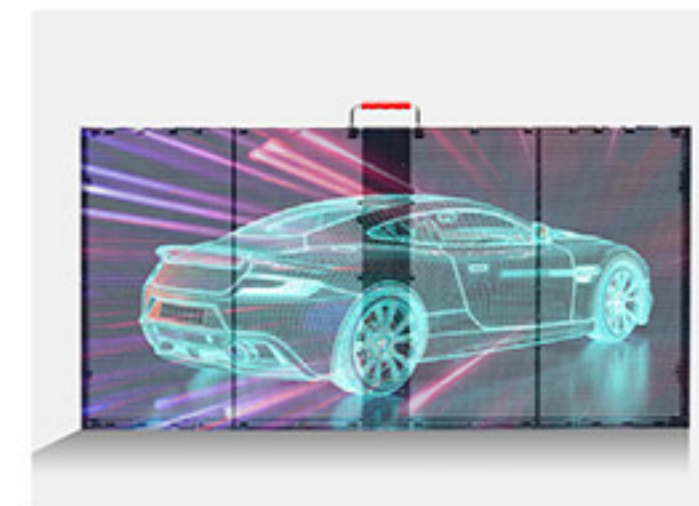

#### 02

##### Thin & Light Cabinet

The thinner and lighter LED display can be easily installed to the original glass curtain wall without any additional steel structure.



#### 03

##### Fast Lock Design

The quick lock design of the display screen has high precision, which is convenient for users to install and disassemble the display screen.



#### 04

##### Delicate Structure

The EA1000TiR LED display adopts precise structural design, hidden transmission lines, and the back of the display is clean and tidy.





## EA1000TiF

### Indoor Fixed Installation Transparent LED Display

EA1000TiF transparent LED display is an important carrier of window advertisements in retail stores. It is light in weight, easy to install and maintain, and has high transparency, which can present novel display effects.



#### 01

##### High Transparency

The transparency of EA1000TiF LED display is as high as 80%, which greatly reduces wind resistance.

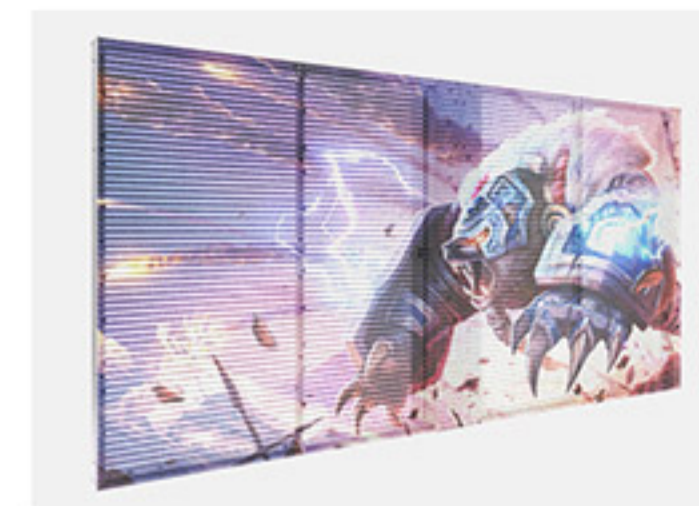

#### 02

##### Delicate Structure

EA1000TiF LED display adopts precise structural design, hidden transmission lines, and the back of the display is clean and tidy.



#### 03

##### Thin & Light Cabinet

The thinner and lighter LED display can be easily installed to the original glass curtain wall without any additional steel structure.



#### 04

##### 500x250mm Size LED Modules

EA1000TiF LED display is suitable for 500x250mm size LED modules and is easy to assemble and maintain.



## EA-iFilm

### Indoor Film Transparent LED Display

EA-iFilm LED film transparent screen has the characteristics of high transparency and ultra-thin. The film transparent screen and the glass curtain wall can be said to hit it off, adding a special aesthetic feeling to urban buildings.

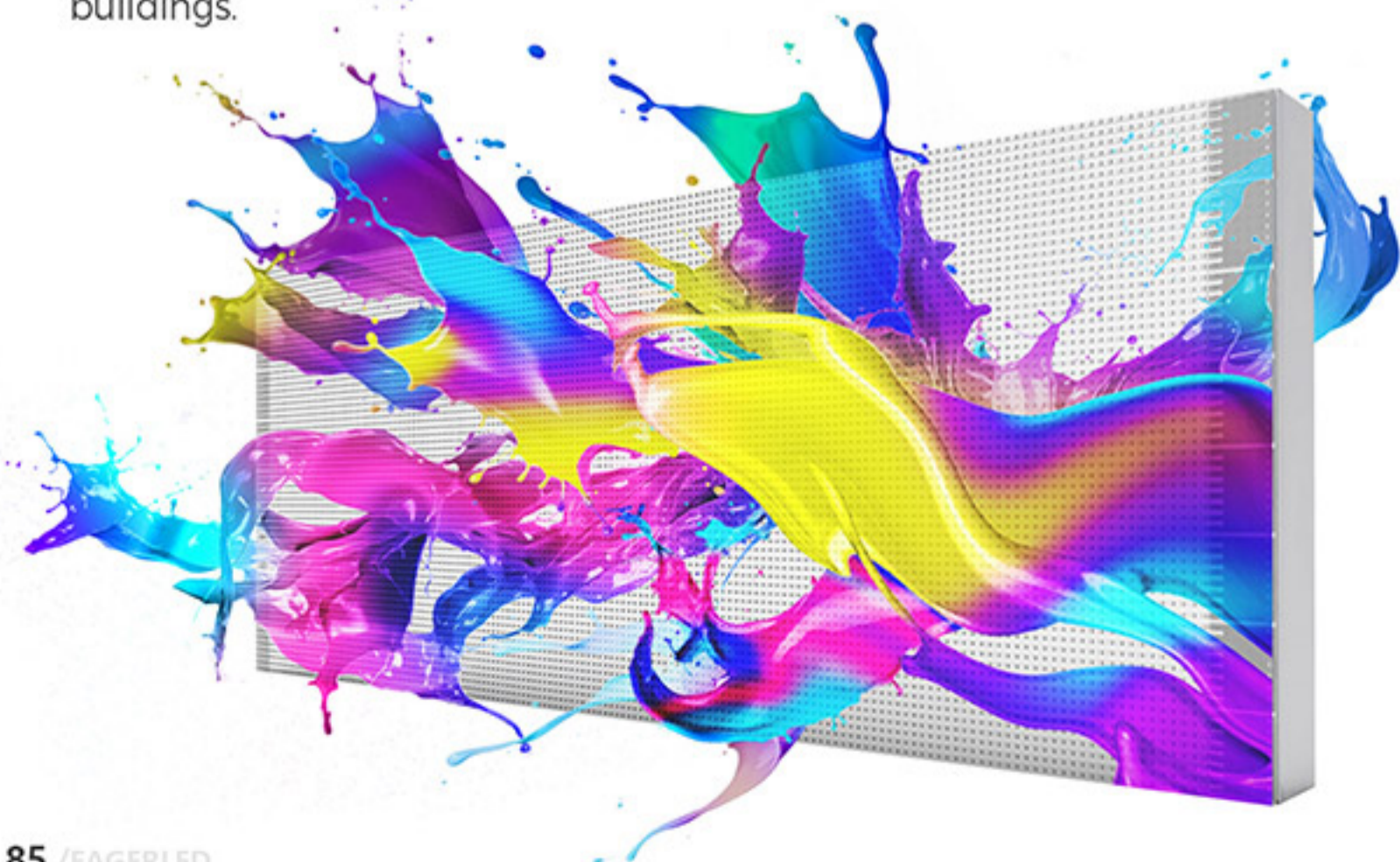

#### 01

##### High Transparency

The transparency of EA-iFilm LED display is as high as 90%, which greatly reduces wind resistance.



#### 02

##### Thin & Light Cabinet

EA-iFilm film LED display wall thickness is about 5mm, weight 6kg/m<sup>2</sup>, light weight, no pressure on the glass.



#### 03

##### High Flexibility

EA-iFilm film LED display can be bent and cut, not limited by size, can be flexibly designed according to customer needs.

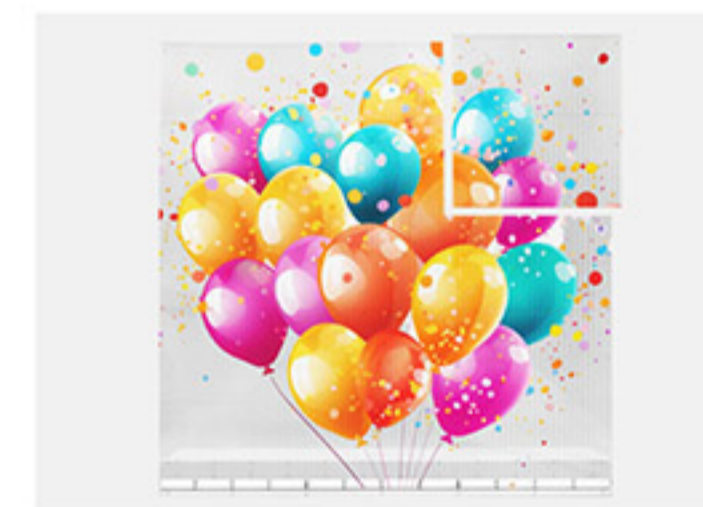

#### 04

##### Easy to Install

EA-iFilm film transparent LED screen is easy to install, just stick to the glass surface directly.





Magnetic Front Service



Thin and Light Design



## EA1920iP3

640x1920mm Indoor Poster LED Display

EA1920iP3 poster LED screens are widely used as posters in shopping malls, exhibitions, hotel lobbies, and bank lobbies. The poster LED display is exquisite in appearance and easy to operate, which is used for advertisement display and product display.

### 01

#### Ultra Thin

EA1920iP3 poster LED display adopts an ultra-thin cabinet design with a thickness of 60mm.



### 02

#### Unique Base Bracket

The base has 4 wheels that allow the poster LED screen to move freely with rotation.



### 03

#### Front Service Design

EA1920iP3 poster LED screen can conveniently maintain the LED module from the front.



### 04

#### Multi-screen Splicing

EA1920iP3 series poster LED screen can realize multi-screen seamless cascading and realize large-screen display.





# EA1920OP1

640x1920mm Outdoor  
Poster LED Display

EA1920OP1 outdoor LED poster display, independent stand with four lightweight wheels for flexible movement. Supports multi-screen splicing, presenting stunning visual impact. IP65 waterproof design, suitable for outdoor activities, allowing you to display eye-catching content in outdoor environments.



## 01

### Combines Larger Screens

EA1920OP1 poster LED screen can be used independently and can be quickly combined into a larger screen.



## 02

### Quick assembly

Three rental screens with a size of 640x640mm can be quickly spliced into one EA1920OP1 poster screen to meet various display needs.

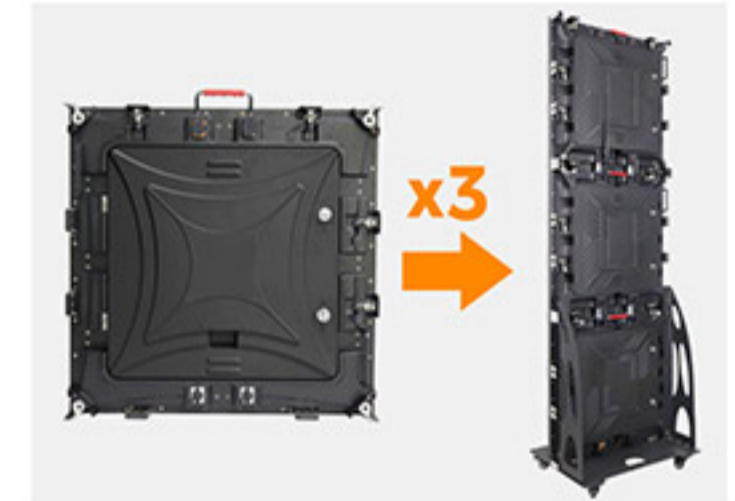

## 03

### Rear Service Design

The back cover of EA1920OP1 poster LED cabinet can be opened to facilitate maintenance operations.



## 04

### Easy to Move

The bottom of EA1920OP1 poster LED screen stand is equipped with four wheels for easy movement.





## EA960SP3

### Outdoor Stadium Perimeter LED Display

EA960SP3 LED display is specially designed for outdoor stadiums, with an independent support system, which can easily adjust the support angle. Its high waterproof rating of IP65 makes it ideal for use in various outdoor environments.

#### 01

##### Rear Service Design

EA960SP3 series LED display boasts a compact structure, and its back cover can be swiftly opened to facilitate maintenance operations.



#### 02

##### Protection Design

EA960SP3 LED display is equipped with protective pads on top to protect athletes from potential collisions.



#### 03

##### Independent Support Structure

EA960SP3 LED display adopts an independent support structure, which can flexibly adjust the support angle.



#### 04

##### IP65 Waterproof

The cabinet protection level of EA960SP3 LED display is as high as IP65.





## EA960SP4

### Outdoor Stadium Perimeter LED Display

EA960SP4 outdoor stadium LED screen has IP65 waterproof rating, rear maintenance design, adjustable bracket and easy installation. It is very suitable for installation around the sports field, so it is also called sports LED screen.

#### 01

##### Rear Service Design

The back cover of EA960SP4LED display supports quick opening design for easy maintenance.



#### 02

##### Protection Design

EA960SP4 LED display is equipped with a rubber cover to ensure safety and user experience.

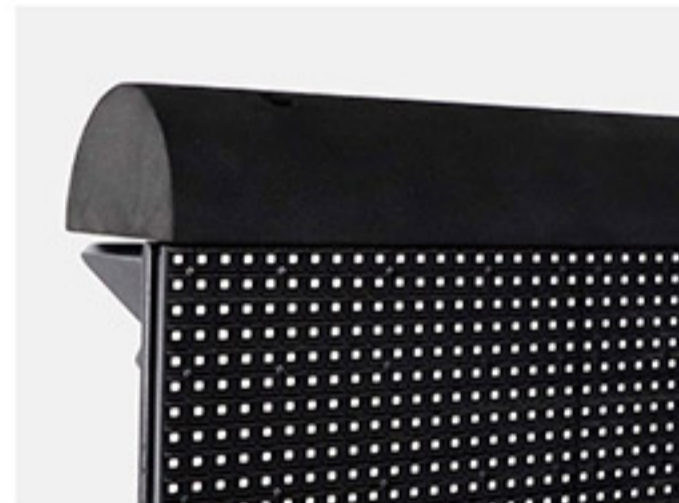

#### 03

##### Independent Support Structure

EA960SP4LED screen is equipped with a carefully designed support structure that can withstand impact and ensure stability.



#### 04

##### IP65 Waterproof

The cabinet protection level of EA960SP4 LED display is as high as IP65.





# LED DISPLAY SCREEN



## EA1280SP1

### Outdoor Stadium Perimeter LED Display

EA1280SP1 stadium perimeter LED display: IP65 waterproof, rear service design, adjustable bracket, easy installation. Ensure efficient operation in various stadium environments and provide audiences with an excellent visual experience.

#### 01

##### Rear Service Design

The back cover of EA1280SP1 LED display can be quickly opened for maintenance operations.



#### 02

##### Protection Design

EA1280SP1 LED display is equipped with a soft mask and rubber cover to protect athletes from injury during competition.



#### 03

##### Independent Support Structure

The support structure of the cabinet can withstand front and rear impacts.



#### 04

##### IP65 Waterproof

The cabinet protection level of EA1280SP1 LED display is as high as IP65.



# EA1600SP

## Outdoor Stadium Perimeter LED Display

EA1600SP LED display is an energy-saving LED display specially designed for stadiums. It has 90-degree upright support, soft mask protection and offers an excellent visual experience with ultra-low heat and power consumption.



**SUPER LEAGUE CHAMPION**

### 01

#### Front and Rear Dual Service

Thanks to its front and rear service mode, the LED panel can be assembled, saving your maintenance cost.



### 02

#### Protection Design

The rubber pads can protect the players from injury while protecting the LED display.



### 03

#### 90 Degrees Support

The LED display is equipped with a 90-degree vertical support frame to ensure the viewing angle of the audience.



### 04

#### 400\*300mm Size Aluminum Module

The aluminum LED module features a fully sealed design that provides high temperature resistance and fast heat dissipation.



# QUALITY CERTIFICATE

# LED DISPLAY CASE (PART)



National High-tech Enterprise Certificate



Alibaba Gold Supplier Assessment Certificate



ISO9001



ISO45001



ISO14001



CE-EMC



CE-LVD



RoHS



FCC



CCC



P3.91 Outdoor Rental LED Display in Congo-2024



P2.5 Indoor HD LED Display in Australia-2024



P2.97 Indoor Rental LED Display in Italy-2024



P10 Outdoor Fixed LED Billboard in Malaysia-2024



P10 Transparent LED Display in Italy-2023



P3 Indoor LED Display in Philippine-2021



P4 Indoor LED Display in America-2021

# 90+ SELLING WELL IN MORE THAN 90 COUNTRIES/REGIONS



P4.81 Outdoor Rental LED Display in Portugal-2023



P1.86 Indoor LED Display in Thailand-2022



P5 Outdoor Ad LED Display in Italy-2020



P1.66 Indoor LED Display in Germany-2020



P2.97 Indoor LED Display in England-2021



P3.91 Stage LED Display in USA-2021

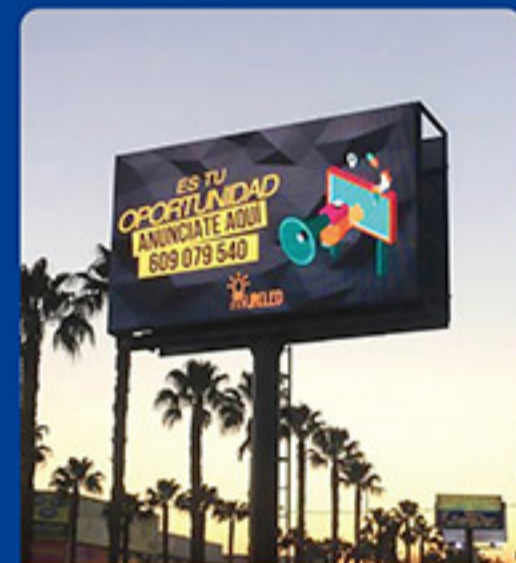

P8 Outdoor LED Display in Spain-2020



P3.91 Rental LED Display in Portugal-2019



P8 Outdoor LED Display in Italy-2018



P6.67 Outdoor LED Display in Italy-2016



P4 Indoor LED Display Sign in America-2021



P4 Indoor LED Display Sign in America-2020



P5 Indoor Ad LED Display in Mexico-2017



P16 Outdoor Ad LED Display in Dubai-2015



[info@eagerled.com](mailto:info@eagerled.com)



[@eagerled](https://www.facebook.com/eagerled)



[@eagerled](https://www.youtube.com/eagerled)



[@eagerleddisplay](https://www.tiktok.com/eagerleddisplay)



# SINCE 2009

EagerLED is a Leading LED Display Manufacturer and Solution Provider.

Website: [www.eagerled.com](http://www.eagerled.com)

Address: Building C, Zhongyu High-Tech Industrial Park,  
Heshuikou, Matian, Guangming, Shenzhen, China